



Orthopedic Trauma Solutions

 www.4umedical.com.tr

The logo features the letters '4U' in a white, stylized font. To the right of the 'U' is a red and white graphic of a human spine, with a registered trademark symbol (®) to its upper right.

4U[®]

Medical

A person is shown in a desert landscape, sitting on a large rock formation. The person is wearing a light-colored, possibly white, outfit and is looking down. The background is a dark, rocky desert with a large, bright, circular object (likely the moon) in the sky. The overall scene is dimly lit, with the person and the rock formation being the primary light sources.

Keeps You
Moving



**PLEASE SCAN QR CODE
TO LEARN MORE!**



Contents

1. Trauma Locking Plate System

- Upper Limb Plates.....
- Clavicula Shaft Locking Plate.....
- Clavicula Distal Locking Plate.....
- Clavicula Hook Locking Plate.....
- Humerus Proximal Locking Plate.....
- Humerus Distal Lateral Locking Plate.....
- Humerus Distal Posterolateral Locking Plate.....
- Humerus Distal Medial Locking Plate.....
- Olecranon Locking Plate.....
- Olecranon Hook Locking Plate.....
- Small 3.5 Compression Plate.....
- Small 3.5 Tp2 Locking Straight Plate.....
- Tubular Locking Plate.....
- Proximal Radius Locking Plate.....
- Distal Radius Volar Locking Plate.....
- Distal Radius Volar Locking Plate Small.....
- Distal Radius Volar Locking Plate Tp2.....
- Radius Distal Dorsal T Locking Plate.....
- Radius Distal Dorsal L Locking Plate.....
- Distal Radius Styloid Plate.....
- Radius Distal/Ulna Hook Locking Plate.....
- Ulna Proximal Hook Locking Plate.....
- Distal Ulna Locking Plate.....
- Coronoid Locking Plate.....
- Metacarpal Hand/Wrist Arthrodesis Plate.....

1. Trauma Locking Plate System

- Lower Limb Plates.....
- Tubular Locking Plate.....
- Femur Proximal Locking Plate.....
- Femur Distal Locking Plate.....
- Femur High Osteotomy Plate 4.5/5.0 mm.....
- Tibia Distal Medial Locking Plate.....
- Tibia Distal Medial Locking Plate 3.5.....
- Large Broad Locking Plate.....
- Large Broad Locking T Plate.....
- Large Broad Locking T Plate.....
- Large Broad T-Support Locking Plate.....
- Tibia High Osteotomy Plate 4.5/5.0 mm.....
- Large Broad L-Support Locking Plate.....
- Proximal Medial/Anteromedial Tibia Locking Plate.....
- Tibia Proximal Lateral Locking Plate.....
- Tibia Distal Lateral Locking Plate.....
- Tibia Distal Lateral Locking Plate Tp2.....
- Pilon Locking Plate.....
- Fibula Locking Plate.....
- Reconstruction Shaft Locking Plate.....
- Calcaneus Locking Plate.....
- Fibula Distal Locking Plate.....
- Small Femur Proximal Hip Locking Plate.....
- Pelvic Reconstruction Curved Locking Plate.....
- Pelvic Symphyseal Plate.....
- Pelvic Reconstruction Straight Locking Plate.....
- Eight Non Locking Plate.....





Contents

2. Trauma Screw

- Locking Self Tapping Cortical Screw.....
 - Locking Self Tapping Cortical Screw \varnothing 1,5 mm.....
 - Locking Self Tapping Cortical Screw \varnothing 2,0 mm.....
 - Locking Self Tapping Cortical Screw \varnothing 2,5 mm.....
 - Locking Self Tapping Cortical Screw \varnothing 2,7 mm.....
 - Locking Self Tapping Cortical Screw \varnothing 3,5 mm.....
 - Locking Self Tapping Cortical Screw \varnothing 5,0 mm.....
- Cortical Self Tapping Screw.....
 - Cortical Self Tapping Screw \varnothing 1,5 mm.....
 - Cortical Self Tapping Screw \varnothing 2,0 mm.....
 - Cortical Self Tapping Screw \varnothing 2,5 mm.....
 - Cortical Self Tapping Screw \varnothing 2,7 mm.....
 - Cortical Self Tapping Screw \varnothing 3,5 mm.....
 - Cortical Self Tapping Screw \varnothing 4,5 mm.....
- Locking Cancellous Spongiose Screw.....
 - Locking Cancellous/Spongiose Screw \varnothing 4,0 mm.....
 - Locking Cancellous/Spongiose Screw \varnothing 5,0 mm.....
 - Cancellous/Spongiose Screw Full Thread \varnothing 4,0 mm.....
 - Cancellous/Spongiose Screw Full Thread \varnothing 6,5 mm.....
 - Cancellous Screw Half Thread \varnothing 4,0 mm.....
 - Cancellous Screw 16 mm Half Thread \varnothing 6,5 mm.....
 - Cancellous Screw 32 mm Thread \varnothing 6,5 mm.....

2. Trauma Screw

- Cannulated Compression Screw.....
 - Cannulated Compression Screw \varnothing 2,7 mm.....
 - Cannulated Compression Screw Full Thread \varnothing 2,7 mm.....
 - Cannulated Compression Screw \varnothing 3,5 mm.....
 - Cannulated Compression Screw \varnothing 4,5 mm.....
 - Cannulated Compression Screw 16 mm Thread \varnothing 6,5 mm.....
 - Cannulated Compression Screw 32 mm Thread \varnothing 6,5 mm.....
 - Cannulated Compression Screw 16 mm Thread \varnothing 7,3 mm.....
 - Cannulated Compression Screw 32 mm Thread \varnothing 7,3 mm.....
 - Locking Cannulated Full Thread Screw \varnothing 2,5 mm.....
 - Locking Cannulated Full Thread Screw \varnothing 3,5 mm.....
 - Locking Cannulated Full Thread Screw \varnothing 5,0 mm.....
 - Locking Cannulated Full Thread Screw \varnothing 6,5 mm.....
 - Washer.....
- Headless Cannulated Screw.....
 - Headless Cannulated Full Thread Screw \varnothing 2,5 mm.....
 - Headless Cannulated Full Thread Screw \varnothing 3,5 mm.....
 - Headless Cannulated Full Thread Screw \varnothing 4,0 mm.....
 - Headless Cannulated Full Thread Screw \varnothing 5,0 mm.....
- Herbert Screw.....
 - Herbert Screw \varnothing 2,5 mm.....
 - Herbert Screw \varnothing 3,0 mm.....
 - Herbert Screw \varnothing 5,0 mm.....



Contents

- Cable Locking Screw.....
- Cap Screw 2,5/3,5/5,0.....
- 3. Mini Plate System.....
 - 1,5 mm Hand / Foot Mini Locking Plate Series.....
 - 1,5 mm Locking / Non - Locking Screw.....
 - 2,0 mm Hand / Foot Mini Locking Plate Series.....
 - 2,0 mm Locking / Non - Locking Screw.....
 - 2,5 mm Hand / Foot Mini Locking Plate Series.....
 - 2,5 mm Locking / Non - Locking Screw.....
 - 2,7 mm Hand / Foot Mini Locking Plate Series.....
 - 2,7 mm Hand / Foot Mini Locking Plate Series.....
 - Metacarpal / Metatarsal Fusion Plate Series.....
 - 2,5 mm Locking / Non - Locking Screw.....
- 4. Nail System.....
 - Humerus Cannulated Nail / Nail Screw.....
 - PFNA Nail.....
 - PFNA Nail Screw.....
 - Intramedullary Cannulated Lateral Femur Nail.....
 - Intramedullary Cannulated Lateral Femur Nail Screw.....
 - Tibial Nail Cannulated.....
 - Tibial Nail Cannulated Screw.....
 - Arthrodesis Nail / Screw.....
 - Flexible Intramedullary Nail / End Cap.....



Introduction



4U Medical Ltd., Co. aims a pioneering leader in sales of high-quality orthopedic trauma solutions. Specializing in supplying of advanced implants and instruments, our mission is to enhance patient outcomes and support medical professionals in the field of orthopedic surgery.

Our comprehensive product portfolio includes quality devices for osteosynthesis, with a focus on the treatment of fractures and other trauma-related conditions. From intramedullary nails to dynamic compression systems, our products are engineered to ensure precision, durability, and optimal healing.

Key offerings include:

- Trauma Screws: A full range of screws (cortical, cancellous, locking, and non-locking) designed to meet the specific needs of fracture stabilization.
- Limited Contact Plates: Innovative plates designed to minimize soft tissue irritation while ensuring secure fixation.
- Fracture Reduction Tools: Specialized instruments to aid in the realignment and stabilization of fractured bones.
- Osteosynthesis Systems: Comprehensive solutions for bone repair and regeneration, supporting complex surgical procedures.

By combining cutting-edge technology with continuous quality control, Medical Ltd., Co. aims to provide surgeons with reliable tools to restore mobility and improve the quality of life for patients. Partner with us for innovative solutions in orthopedic trauma care.

4U Medical Ltd., Co. – Keeps You Moving.

CLAVICULA SHAFT LOCKING PLATE

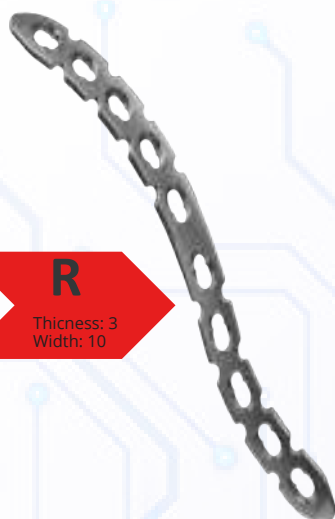

R

Thickness: 3
Width: 10

Screws

- Ø3.5 mm – Locking Self Tapping Screw
- Ø3.5 mm – Cortical Self Tapping Screw
- Ø4,0 mm – Locking Cancellous Screw
- Ø4.0 mm – Cancellous Screw

Code Holes Side Length

Code	Holes	Side	Length
1011213504	4	R	49
1011213505	5	R	60
1011213506	6	R	72
1011213507	7	R	84
1011213508	8	R	96
1011213509	9	R	107
1011213510	10	R	118
1011213511	11	R	129
1011213512	12	R	140
1011223504	4	L	49
1011223505	5	L	60
1011223506	6	L	72
1011223507	7	L	84
1011223508	8	L	96
1011223509	9	L	107
1011223510	10	L	118
1011223511	11	L	129
1011223512	12	L	140

CLAVICULA DISTAL LOCKING PLATE

Code Holes Side Length

Code	Holes	Side	Length
1011313503	3	R	54
1011313504	4	R	67
1011313505	5	R	80
1011313506	6	R	93
1011313507	7	R	106
1011313508	8	R	119
1011313509	9	R	132
1011313510	10	R	145
1011323503	3	L	54
1011323504	4	L	67
1011323505	5	L	80
1011323506	6	L	93
1011323507	7	L	106
1011323508	8	L	119
1011323509	9	L	132
1011323510	10	L	145

Screws

- Ø 2.5 mm – Locking Self Tapping Screw
- Ø 3.5 mm – Locking Self Tapping Screw
- Ø 3.5 mm – Cortical Self Tapping Screw
- Ø 4,0 mm – Locking Cancellous Screw
- Ø 4.0 mm – Cancellous Screw



R

Thickness: 3,4
Width: 10

CLAVICULA HOOK LOCKING PLATE



R

Thickness: 3,5
Width: 11

Screws

- Ø 3.5 mm – Locking Self Tapping Screw
- Ø 3.5 mm – Cortical Self Tapping Screw
- Ø 4,0 mm – Locking Cancellous Screw
- Ø 4.0 mm – Cancellous Screw

Code Holes Side Length

Code	Holes	Side	Length
1011513503	3	R	57
1011513504	4	R	72
1011513505	5	R	87
1011513506	6	R	102
1011513507	7	R	117
1011513508	8	R	132
1011523503	3	L	57
1011523504	4	L	72
1011523505	5	L	87
1011523506	6	L	102
1011523507	7	L	117
1011523508	8	L	132

HUMERUS PROXIMAL LOCKING PLATE

Thickness: 4
Width: 12

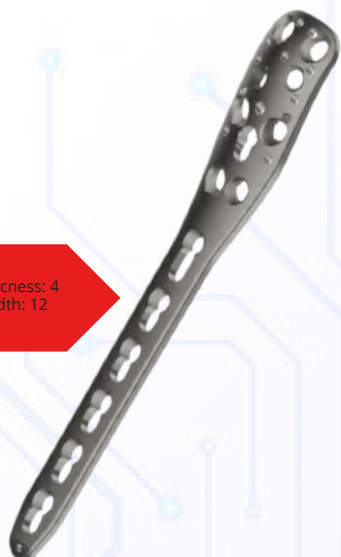

Screws

- Ø 3.5 mm – Locking Self Tapping Screw
- Ø 3.5 mm – Cortical Self Tapping Screw
- Ø 4,0 mm – Locking Cancellous Screw
- Ø 4.0 mm – Cancellous Screw

Code Holes Side Length

1021103503	3	-	105
1021103504	4	-	122
1021103505	5	-	139
1021103506	6	-	156
1021103507	7	-	173
1021103508	8	-	190
1021103509	9	-	207
1021103510	10	-	224
1021103511	11	-	241
1021103512	12	-	258
1021103513	13	-	275

HUMERUS DISTAL LATERAL LOCKING PLATE

Code Holes Side Length

1021313503	3	R	85
1021313504	4	R	98
1021313505	5	R	111
1021313506	6	R	124
1021313507	7	R	137
1021313508	8	R	150
1021313509	9	R	163
1021313510	10	R	176
1021313511	11	R	189
1021313512	12	R	202
1021313513	13	R	215
1021323503	3	L	85
1021323504	4	L	98
1021323505	5	L	111
1021323506	6	L	124
1021323507	7	L	137
1021323508	8	L	150
1021323509	9	L	163
1021323510	10	L	176
1021323511	11	L	189
1021323512	12	L	202
1021323513	13	L	215

Screws

- Ø3.5 mm – Locking Self Tapping Screw
- Ø3.5 mm – Cortical Self Tapping Screw
- Ø4,0 mm – Locking Cancellous Screw
- Ø4.0 mm – Cancellous Screw

R
Thickness: 3,5
Width: 11



HUMERUS DISTAL POSTEROLATERAL LOCKING PLATE

R
Thickness: 3
Width: 12



Screws

- Ø 2.5 mm – Locking Self Tapping Screw
- Ø 2.5 mm – Cortical Self Tapping Screw
- Ø 3.5 mm – Locking Self Tapping Screw
- Ø 3.5 mm – Cortical Self Tapping Screw
- Ø 4,0 mm – Locking Cancellous Screw
- Ø 4.0 mm – Cancellous Screw

Code Holes Side Length

1021613503	3	R	74
1021613504	4	R	85
1021613505	5	R	98
1021613506	6	R	111
1021613507	7	R	124
1021613508	8	R	137
1021613509	9	R	150
1021613510	10	R	163
1021613511	11	R	176
1021613512	12	R	189
1021613513	13	R	202
1021623503	3	L	74
1021623504	4	L	85
1021623505	5	L	98
1021623506	6	L	111
1021623507	7	L	124
1021623508	8	L	137
1021623509	9	L	150
1021623510	10	L	163
1021623511	11	L	176
1021623512	12	L	189
1021623513	13	L	202

HUMERUS DISTAL MEDIAL LOCKING PLATE

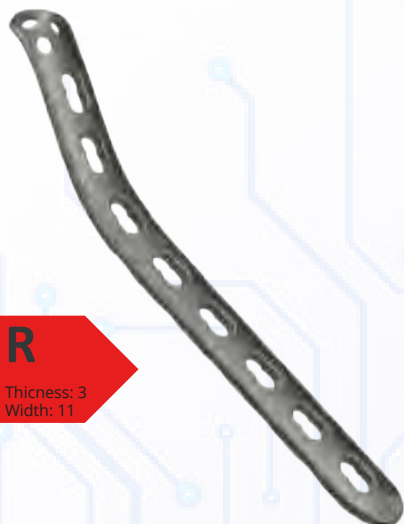

R

Thickness: 3
Width: 11

Screws

- Ø 2,5 mm – Locking Self Tapping Screw
- Ø 2,5 mm – Cortical Self Tapping Screw
- Ø 3.5 mm – Locking Self Tapping Screw
- Ø 3.5 mm – Cortical Self Tapping Screw
- Ø 4,0 mm – Locking Cancellous Screw
- Ø 4.0 mm – Cancellous Screw

Code

Holes Side Length

1021713503	3	R	70
1021713504	4	R	82
1021713505	5	R	95
1021713506	6	R	108
1021713507	7	R	121
1021713508	8	R	134
1021713509	9	R	147
1021713510	10	R	160
1021713511	11	R	173
1021713512	12	R	186
1021713513	13	R	199
1021723503	3	L	70
1021723504	4	L	82
1021723505	5	L	95
1021723506	6	L	108
1021723507	7	L	121
1021723508	8	L	134
1021723509	9	L	147
1021723510	10	L	160
1021723511	11	L	173
1021723512	12	L	186
1021723513	13	L	199

OLECRANON LOCKING PLATE

Code

Holes Side Length

1031113503	3	R	101
1031113504	4	R	110
1031113505	5	R	125
1031113506	6	R	138
1031113507	7	R	151
1031113508	8	R	164
1031113509	9	R	177
1031113510	10	R	190
1031113511	11	R	203
1031113512	12	R	216
1031113513	13	R	229
1031123503	3	L	101
1031123504	4	L	110
1031123505	5	L	125
1031123506	6	L	138
1031123507	7	L	151
1031123508	8	L	164
1031123509	9	L	177
1031123510	10	L	190
1031123511	11	L	203
1031123512	12	L	216
1031123513	13	L	229

Screws

- Ø 3.5 mm – Locking Self Tapping Screw
- Ø 3.5 mm – Cortical Self Tapping Screw
- Ø 4,0 mm – Locking Cancellous Screw
- Ø 4.0 mm – Cancellous Screw



R

Thickness: 3
Width: 10

OLECRANON HOOK LOCKING PLATE



Thickness: 3
Width: 10

Screws

- Ø 3.5 mm – Locking Self Tapping Screw
- Ø 3.5 mm – Cortical Self Tapping Screw
- Ø 4,0 mm – Locking Cancellous Screw
- Ø 4.0 mm – Cancellous Screw

Code

Holes Side Length

8081203503	3	-	53
8081203504	4	-	67
8081203505	5	-	81
8081203506	6	-	95
8081203507	7	-	109
8081203508	8	-	123
8081203509	9	-	137

SMALL 3.5 COMPRESSION PLATE

Thickness: 3,5
Width: 12

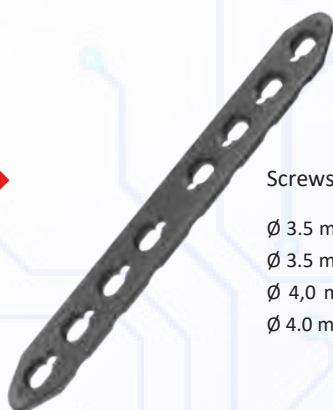

Screws

- Ø 3.5 mm – Locking Self Tapping Screw
- Ø 3.5 mm – Cortical Self Tapping Screw
- Ø 4,0 mm – Locking Cancellous Screw
- Ø 4.0 mm – Cancellous Screw

Code	Holes	Side	Length
1031283524	4	-	62
1031283515	5	-	74,5
1031283516	6	-	87
1031283517	7	-	99,5
1031283518	8	-	112
1031283519	9	-	124,5
1031283510	10	-	137
1031283511	11	-	149,5
1031283512	12	-	162
1031283513	13	-	174,5
1031283514	14	-	187

SMALL 3.5 TP2 LOCKING STRAIGHT PLATE

Code	Holes	Side	Length
1031383504	4	-	62
1031383505	5	-	74,5
1031383506	6	-	87
1031383507	7	-	99,5
1031383508	8	-	112
1031383509	9	-	124,5
1031383510	10	-	137
1031383511	11	-	149,5
1031383512	12	-	162
1031383513	13	-	174,5
1031383514	14	-	187

Screws

- Ø 3.5 mm – Locking Self Tapping Screw
- Ø 3.5 mm – Cortical Self Tapping Screw
- Ø 4,0 mm – Locking Cancellous Screw
- 4.0 mm – Cancellous Screw

Thickness: 3,5
Width: 13



TUBULAR LOCKING PLATE

Thickness: 1,4
Width: 10



Screws

- Ø 3.5 mm – Locking Self Tapping Screw
- Ø 3.5 mm – Cortical Self Tapping Screw
- Ø 4,0 mm – Locking Cancellous Screw
- 4.0 mm – Cancellous Screw

Code	Holes	Side	Length
1081203504	4	-	54
1081203505	5	-	66
1081203506	6	-	78
1081203507	7	-	90
1081203508	8	-	102
1081203509	9	-	114
1081203510	10	-	126
1081203511	11	-	138
1081203512	12	-	150

PROXIMAL RADIUS LOCKING PLATE

R

Thickness: 1,9
Width: 9



Screws

Ø 2.5 mm – Locking Self Tapping Screw

Ø 2.5 mm – Cortical Self Tapping Screw

Code

Holes Side Length

1031112502	2	R	33
1031112503	3	R	42
1031112504	4	R	51
1031112505	5	R	60
1031112506	6	R	69
1031122502	2	L	33
1031122503	3	L	42
1031122504	4	L	51
1031122505	5	L	60
1031122506	6	L	69

DISTAL RADIUS VOLAR LOCKING PLATE

Code

Holes Side Length

1031312502	2	R	51
1031312503	3	R	59
1031312504	4	R	67
1031312505	5	R	75
1031312506	6	R	83
1031312507	7	R	91
1031312508	8	R	99
1031312509	9	R	107
1031322502	2	L	51
1031322503	3	L	59
1031322504	4	L	67
1031322505	5	L	75
1031322506	6	L	83
1031322507	7	L	91
1031322508	8	L	99
1031322509	9	L	107

Screws

Ø 2.5 mm – Locking Self Tapping Screw

Ø 2.5 mm – Cortical Self Tapping Screw

R

Thickness: 2
Width: 8,5



DISTAL RADIUS VOLAR LOCKING PLATE SMALL

R

Thickness: 2
Width: 8,5



Screws

Ø 2.5 mm – Locking Self Tapping Screw

Ø 2.5 mm – Cortical Self Tapping Screw

Code

Holes Side Length

1031332502	2	R	51
1031332503	3	R	59
1031332504	4	R	67
1031332505	5	R	75
1031332506	6	R	83
1031332507	7	R	91
1031332508	8	R	99
1031332509	9	R	107
1031342502	2	L	51
1031342503	3	L	59
1031342504	4	L	67
1031342505	5	L	75
1031342506	6	L	83
1031342507	7	L	91
1031342508	8	L	99
1031342509	9	L	107

DISTAL RADIUS VOLAR LOCKING PLATE TP2

R
Thickness: 2
Width: 8,5



Screws
 Ø 2.5 mm – Locking Self Tapping Screw
 Ø 2.5 mm – Cortical Self Tapping Screw

Code	Holes	Side	Length
1031352502	2	R	51
1031352503	3	R	59
1031352504	4	R	67
1031352505	5	R	75
1031352506	6	R	83
1031352507	7	R	91
1031352508	8	R	99
1031352509	9	R	107
1031362502	2	L	51
1031362503	3	L	59
1031362504	4	L	67
1031362505	5	L	75
1031362506	6	L	83
1031362507	7	L	91
1031362508	8	L	99
1031362509	9	L	107

RADIUS DISTAL DORSAL T LOCKING PLATE

Code	Holes	Side	Length
1031402503	3	-	34
1031402504	4	-	40
1031402505	5	-	46
1031402506	6	-	52

Screws
 Ø 2.5 mm – Locking Self Tapping Screw
 Ø 2.5 mm – Cortical Self Tapping Screw



Thickness: 2
Width: 7

RADIUS DISTAL DORSAL L LOCKING PLATE

R
Thickness: 1,8
Width: 7,5



Screws
 Ø 2.5 mm – Locking Self Tapping Screw
 Ø 2.5 mm – Cortical Self Tapping Screw

Code	Holes	Side	Length
1031412505	3	R	42
1031412506	4	R	48
1031412507	5	R	54
1031412508	6	R	60
1031422501	3	L	42
1031422502	4	L	48
1031422503	5	L	54
1031422504	6	L	60

DISTAL RADIUS STYLOID PLATE

Code	Holes	Side	Length
1031402511	4	-	68,5

Screws
 Ø 2.5 mm – Locking Self Tapping Screw
 Ø 2.5 mm – Cortical Self Tapping Screw

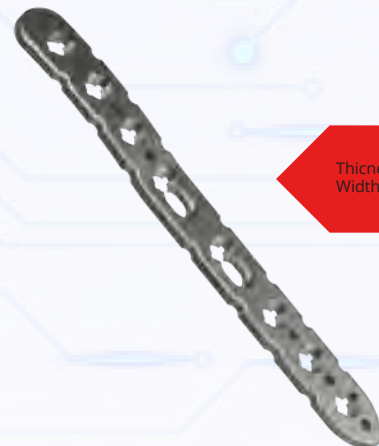

Thickness: 1,8
Width: 7,5

RADIUS DISTAL/ULNA HOOK LOCKING PLATE

Thickness: 1,7
Width: 6,2

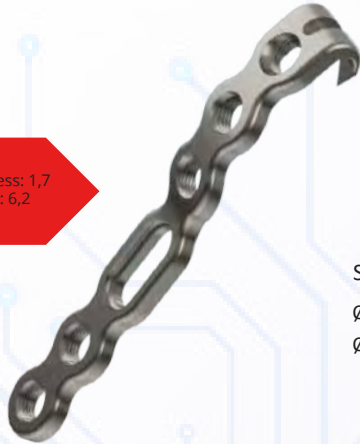

Screws

- Ø 2.5 mm – Locking Self Tapping Screw
- Ø 2.5 mm – Cortical Self Tapping Screw

Code

Holes Side Length

1031402510

6

-

42

ULNA PROXIMAL HOOK LOCKING PLATE

Code

Holes Side Length

1041103503	3	-	53
1041103504	4	-	67
1041103505	5	-	81
1041103506	6	-	95
1041103507	7	-	109
1041103508	8	-	123
1041103509	9	-	137
1041103510	10	-	151

Screws

- Ø 3.5 mm – Locking Self Tapping Screw
- Ø 3.5 mm – Cortical Self Tapping Screw
- Ø 4,0 mm – Locking Cancellous Screw
- Ø 4.0 mm – Cancellous Screw

Thickness: 3
Width: 10



DISTAL ULNA LOCKING PLATE

R

Thickness: 2,5
Width: 9



Screws

- Ø 2.5 mm – Locking Self Tapping Screw
- Ø 2.7 mm – Locking Self Tapping Screw
- Ø 3.5 mm – Cortical Self Tapping Screw
- Ø 3.5 mm – Locking Self Tapping Screw

Code

Holes Side Length

1041313503	3	R	49
1041313504	4	R	60
1041313505	5	R	71
1041313506	6	R	86
1041313507	7	R	97
1041313508	8	R	112
1041313509	9	R	123
1041323503	3	L	49
1041323504	4	L	60
1041323505	5	L	71
1041323506	6	L	86
1041323507	7	L	97
1041323508	8	L	112
1041323509	9	L	123

CORONOID LOCKING PLATE

Code

Holes Side Length

1001000150	2	R	Small
1001000151	2	R	Medium
1001000152	2	R	Large
1001000250	2	L	Small
1001000251	2	L	Medium
1001000252	2	L	Large

Screws

- Ø 3.5 mm – Locking Self Tapping Screw
- Ø 3.5 mm – Cortical Self Tapping Screw
- Ø 4,0 mm – Locking Cancellous Screw
- Ø 4.0 mm – Cancellous Screw

R
Thickness: 2,0
Width: 9,0



METACARPAL HAND/WRIST ARTHRODESIS PLATE

Code

1031902500

Size

S



Code

1031902501
1031902502

Size

M
L



Thickness: 3
Width: 10

Screws

- Ø 2.5 mm – Locking Self Tapping Screw
- Ø 2.7 mm – Locking Self Tapping Screw
- Ø 3.5 mm – Locking Self Tapping Screw
- Ø 3.5 mm – Cortical Self Tapping Screw
- Ø 4.0 mm – Cancellous Screw

FEMUR PROXIMAL LOCKING PLATE



R

Thickness: 5,5
Width: 17,5

Screws

Ø 5.0 mm – Locking Self Tapping Screw Ø
4.5 mm – Cortical Self Tapping Screw Ø 5.0
mm – Locking Cancellous Screw Ø 6.5 mm –
Locking Cannulated Full Thread Screw

Code	Holes	Side	Length
------	-------	------	--------

2061115503	3	R	120
2061115504	4	R	138
2061115505	5	R	156
2061115506	6	R	174
2061115507	7	R	192
2061115508	8	R	210
2061115509	9	R	228
2061115510	10	R	246
2061115511	11	R	264
2061115512	12	R	282
2061115513	13	R	300
2061127003	3	L	120
2061127004	4	L	138
2061127005	5	L	156
2061127006	6	L	174
2061127007	7	L	192
2061127008	8	L	210
2061127009	9	L	228
2061127010	10	L	246
2061127011	11	L	264
2061127012	12	L	282
2061127013	13	L	300

FEMUR DISTAL LOCKING PLATE

Code	Holes	Side	Length
------	-------	------	--------

2061316005	5	R	160
2061316006	6	R	178
2061316007	7	R	196
2061316008	8	R	214
2061316009	9	R	232
2061316010	10	R	250
2061316011	11	R	268
2061316012	12	R	286
2061316013	13	R	304
2061325005	5	L	160
2061325006	6	L	178
2061325007	7	L	196
2061326008	8	L	214
2061326009	9	L	232
2061326010	10	L	250
2061326011	11	L	268
2061326012	12	L	286
2061326013	13	L	304

R

Screws

Ø 5.0 mm – Locking Self Tapping Screw
Ø 4.5 mm – Cortical Self Tapping Screw
Ø 5.0 mm – Locking Cancellous Screw



R

Thickness: 5,5
Width: 16

FEMUR HIGH OSTEOTOMY PLATE 4.5/5.0 MM



R

Thickness: 4,3
Width: 14,1

Screws

Ø 5.0 mm – Locking Self Tapping Screw
Ø 4.5 mm – Cortical Self Tapping Screw
Ø 5.0 mm – Locking Cancellous Screw

Code	Size	Hole	Length
------	------	------	--------

2031915007	R	4	113,5
2031925008	L	4	113,5

TIBIA DISTAL MEDIAL LOCKING PLATE

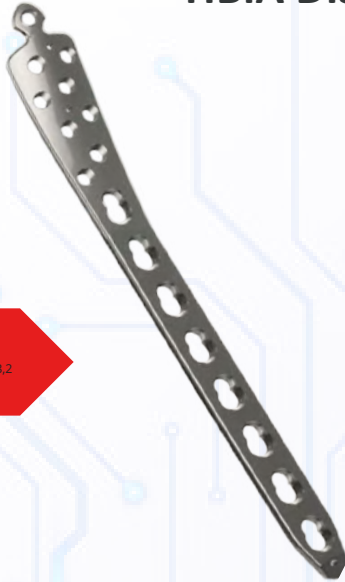

R

Thickness: 3,2
Width: 14

Screws

Ø 3.5 mm – Locking Self Tapping Screw
 Ø 3.5 mm – Cortical Self Tapping Screw
 Ø 4,0 mm – Locking Cancellous Screw Ø
 4.0 mm – Cancellous Screw Ø 5.0 mm –
 Locking Self Tapping Screw Ø 4.5 mm –
 Cortical Self Tapping Screw Ø 5.0 mm –
 Locking Cancellous Screw

Code	Holes	Side	Length
------	-------	------	--------

2071315003	3	R	113
2071315004	4	R	129
2071315005	5	R	145
2071315006	6	R	161
2071315007	7	R	177
2071315008	8	R	193
2071315009	9	R	209
2071315010	10	R	225
2071315011	11	R	241
2071315012	12	R	257
2071315013	13	R	273
2071325003	3	L	113
2071325004	4	L	129
2071325005	5	L	145
2071325006	6	L	161
2071325007	7	L	177
2071325008	8	L	193
2071325009	9	L	209
2071325010	10	L	225
2071325011	11	L	241
2071325012	12	L	257
2071325013	13	L	273

TIBIA DISTAL MEDIAL LOCKING PLATE 3.5

Code	Holes	Side	Length
------	-------	------	--------

2071335003	3	R	117
2071335004	4	R	130
2071335005	5	R	143
2071335006	6	R	156
2071335007	7	R	169
2071335008	8	R	182
2071335009	9	R	195
2071335010	10	R	208
2071335011	11	R	221
2071335012	12	R	234
2071335013	13	R	247
2071345003	3	L	117
2071345004	4	L	130
2071345005	5	L	143
2071345006	6	L	156
2071345007	7	L	169
2071345008	8	L	182
2071345009	9	L	195
2071345010	10	L	208
2071345011	11	L	221
2071345012	12	L	234
2071345013	13	L	247

Screws

Ø 3.5 mm – Locking Self Tapping Screw
 Ø 3.5 mm – Cortical Self Tapping Screw
 Ø 4,0 mm – Locking Cancellous Screw Ø
 4.0 mm – Cancellous Screw



R

Thickness: 3,2
Width: 14

LARGE NARROW LOCKING PLATE

Thickness: 4,5
Width: 14



Code	Holes	Side	Length
------	-------	------	--------

2021205004	4	-	88
2021205005	5	-	106
2021205006	6	-	124
2021205007	7	-	142
2021205008	8	-	160
2021205009	9	-	178
2021205010	10	-	196
2021205011	11	-	214
2021205012	12	-	232
2021205013	13	-	250
2021205014	14	-	268
2021205015	15	-	286
2021205016	16	-	304
2021205018	18	-	340
2021205020	20	-	376

Screws

Ø 5.0 mm – Locking Self Tapping Screw
 Ø 4.5 mm – Cortical Self Tapping Screw
 Ø 5.0 mm – Locking Cancellous Screw

LARGE BROAD LOCKING PLATE



Thickness: 5,5
Width: 18

Screws

- Ø 5.0 mm – Locking Self Tapping Screw
- Ø 4.5 mm – Cortical Self Tapping Screw
- Ø 5.0 mm – Locking Cancellous Screw

Code Holes Side Length

2061205005	5	-	105
2061205006	6	-	123
2061205007	7	-	141
2061205008	8	-	159
2061205009	9	-	177
2061205010	10	-	195
2061205011	11	-	213
2061205012	12	-	231
2061205013	13	-	249
2061205014	14	-	267
2061205015	15	-	285
2061205016	16	-	303
2061205018	18	-	339
2061205020	20	-	375

LARGE BROAD LOCKING T PLATE

Code Holes Side Length

2071105003	3	-	73
2071105004	4	-	89
2071105005	5	-	105
2071105006	6	-	121
2071105007	7	-	137
2071105008	8	-	153

Screws

- Ø 5.0 mm – Locking Self Tapping Screw
- Ø 4.5 mm – Cortical Self Tapping Screw
- Ø 5.0 mm – Locking Cancellous Screw



Thickness: 3
Width: 15,5

LARGE BROAD T-SUPPORT LOCKING PLATE

Thickness: 3,5
Width: 15,5

Screws

- Ø 5.0 mm – Locking Self Tapping Screw
- Ø 5.0 mm – Locking Cancellous Screw
- Ø 4.5 mm – Cortical Self Tapping Screw

Code Holes Side Length

2071105014	4	-	116
2071105015	5	-	134
2071105016	6	-	152

TIBIA HIGH OSTEOTOMY PLATE 4.5/5.0 MM

Code Size Side Length

2031923506	L	-	114
2031913505	S	-	112

- Ø 5.0 mm – Locking Self Tapping Screw
- Ø 4.5 mm – Cortical Self Tapping Screw
- Ø 5.0 mm – Locking Cancellous Screw

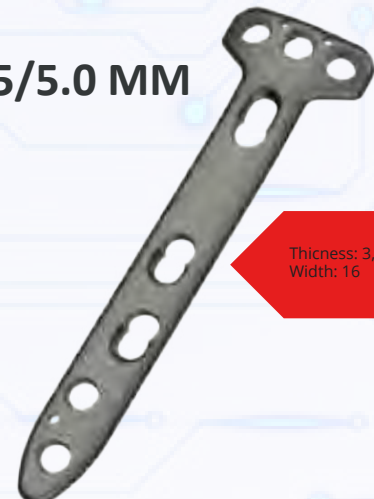

Thickness: 3,5
Width: 16

LARGE BROAD L-SUPPORT LOCKING PLATE



R

Thickness: 3
Width: 16

Screws

Ø 5.0 mm – Locking Self Tapping Screw

Ø 5.0 mm – Locking Cancellous Screw

Ø 4.5 mm – Cortical Self Tapping Screw

Code

Holes Side Length

2071115003	3	R	73
2071115004	4	R	89
2071115005	5	R	105
2071115006	6	R	121
2071115007	7	R	137
2071115008	8	R	153
2071125003	3	L	73
2071125004	4	L	89
2071125005	5	L	105
2071125006	6	L	121
2071125007	7	L	137
2071125008	8	L	153

PROXIMAL MEDIAL/ANTEROMEDIAL TIBIA LOCKING PLATE

Code

Holes Side Length

1071113504	4	R	108
1071113505	5	R	125
1071113506	6	R	142
1071113507	7	R	159
1071113508	8	R	176
1071113509	9	R	193
1071123504	4	L	108
1071123505	5	L	125
1071123506	6	L	142
1071123507	7	L	159
1071123508	8	L	176
1071123509	9	L	193

Screws

Ø 5.0 mm – Locking Self Tapping

Screw Ø 4.5 mm – Cortical Self

Tapping Screw Ø 5.0 mm – Locking

Cancellous Screw



R

Thickness: 3,5
Width: 13,5

TIBIA PROXIMAL LATERAL LOCKING PLATE



R

Thickness: 4,5
Width: 15

Screws

Ø 5.0 mm – Locking Self Tapping Screw

Ø 5.0 mm – Locking Cancellous Screw

Ø 4.5 mm – Cortical Self Tapping Screw

Code

Holes Side Length

2071113503	3	R	112
2071113504	4	R	131
2071113505	5	R	150
2071113506	6	R	169
2071113507	7	R	188
2071113508	8	R	207
2071113509	9	R	226
2071113510	10	R	245
2071113511	11	R	264
2071113512	12	R	283
2071113513	13	R	302
2071123503	3	L	112
2071123504	4	L	131
2071123505	5	L	150
2071123506	6	L	169
2071123507	7	L	188
2071123508	8	L	207
2071123509	9	L	226
2071125010	10	L	245
2071125011	11	L	264
2071125012	12	L	283
2071125013	13	L	302

TIBIA DISTAL LATERAL LOCKING PLATE

R
Thickness: 3,8
Width: 13

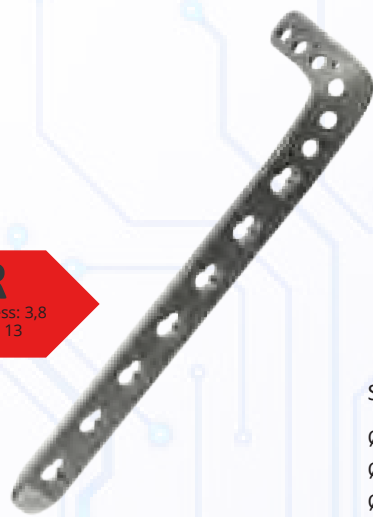

Screws

- Ø 3.5 mm – Locking Self Tapping Screw
- Ø 3.5 mm – Cortical Self Tapping Screw
- Ø 4,0 mm – Locking Cancellous Screw
- Ø 4.0 mm – Cancellous Screw

Code	Holes	Side	Length
1071313503	3	R	71
1071313504	4	R	84
1071313505	5	R	97
1071313506	6	R	110
1071313507	7	R	123
1071313508	8	R	136
1071313509	9	R	149
1071313510	10	R	162
1071313511	11	R	175
1071313512	12	R	188
1071313513	13	R	201
1071323503	3	L	71
1071323504	4	L	84
1071323505	5	L	97
1071323506	6	L	110
1071323507	7	L	123
1071323508	8	L	136
1071323509	9	L	149
1071323510	10	L	162
1071323511	11	L	175
1071323512	12	L	188
1071323513	13	L	201

TIBIA DISTAL LATERAL LOCKING PLATE TP2

Code Holes Side Length

1071333503	3	R	71
1071333504	4	R	84
1071333505	5	R	97
1071333506	6	R	110
1071333507	7	R	123
1071333508	8	R	136
1071333509	9	R	149
1071333510	10	R	162
1071333511	11	R	175
1071333512	12	R	188
1071333513	13	R	201
1071343503	3	L	71
1071343504	4	L	84
1071343505	5	L	97
1071343506	6	L	110
1071343507	7	L	123
1071343508	8	L	136
1071343509	9	L	149
1071343510	10	L	162
1071343511	11	L	175
1071343512	12	L	188
1071343513	13	L	201

Screws

- Ø 3.5 mm – Locking Self Tapping Screw
- Ø 3.5 mm – Cortical Self Tapping Screw
- Ø 4,0 mm – Locking Cancellous Screw
- Ø 4.0 mm – Cancellous Screw



R
Thickness: 3,8
Width: 13

PILON LOCKING PLATE

Thickness: 3,1
Width: 11

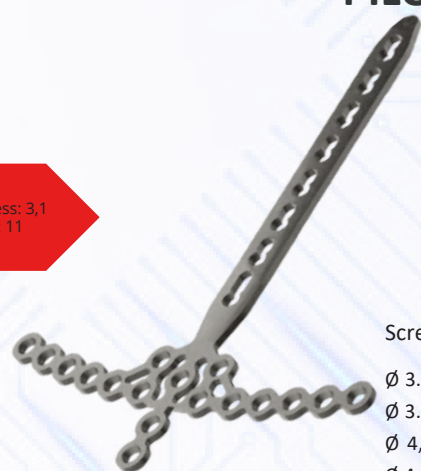

Screws

- Ø 3.5 mm – Locking Self Tapping Screw
- Ø 3.5 mm – Cortical Self Tapping Screw
- Ø 4,0 mm – Locking Cancellous Screw
- Ø 4.0 mm – Cancellous Screw

Code	Holes	Length
1071203515	5	110
1071203516	6	125
1071203517	7	140
1071203518	8	158
1071203519	9	170

FIBULA LOCKING PLATE

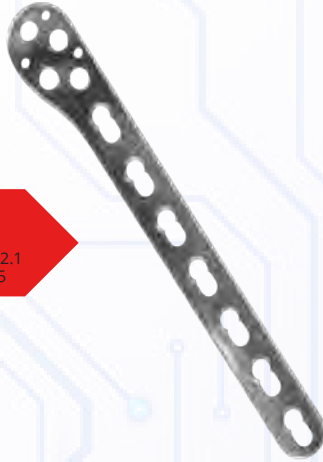

R

Thickness: 2,1
Width: 9,5

Screws

- Ø 3.5 mm – Locking Self Tapping Screw
- Ø 3.5 mm – Cortical Self Tapping Screw
- Ø 4,0 mm – Locking Cancellous Screw
- Ø 4.0 mm – Cancellous Screw

Code	Holes	Side	Length
------	-------	------	--------

1081613502	2	R	50
1081613503	3	R	62
1081613504	4	R	74
1081613505	5	R	86
1081613506	6	R	98
1081613507	7	R	110
1081613508	8	R	122
1081613509	9	R	134
1081613510	10	R	146
1081613511	11	R	158
1081613512	12	R	170
1081613513	13	R	182
1081693502	2	L	50
1081693503	3	L	62
1081693504	4	L	74
1081693505	5	L	86
1081693506	6	L	98
1081693507	7	L	110
1081693508	8	L	122
1081693509	9	L	134
1081693510	10	L	146
1081693511	11	L	158
1081693512	12	L	170
1081693513	13	L	182

FIBULA DISTAL LOCKING PLATE

Code	Holes	Side	Length
------	-------	------	--------

1081313502	2	R	54
1081313503	3	R	66
1081313504	4	R	79
1081313505	5	R	92
1081313506	6	R	105
1081313507	7	R	118
1081313508	8	R	131
1081313509	9	R	144
1081313510	10	R	157
1081313511	11	R	170
1081313512	12	R	183
1081313513	13	R	196
1081323502	2	L	54
1081323503	3	L	66
1081323504	4	L	79
1081323505	5	L	92
1081323506	6	L	105
1081323507	7	L	118
1081323508	8	L	131
1081323509	9	L	144
1081323510	10	L	157
1081323511	11	L	170
1081323512	12	L	183
1081323513	13	L	196

Screws

- Ø 2.5 mm – Locking Self Tapping Screw
- Ø 2.5 mm – Cortical Self Tapping Screw
- Ø 3.5 mm – Locking Self Tapping Screw
- Ø 3.5 mm – Cortical Self Tapping Screw
- Ø 4,0 mm – Locking Cancellous Screw



R

Thickness: 3
Width: 10

RECONSTRUCTION SHAFT LOCKING PLATE

Code	Holes	Side	Length
------	-------	------	--------

1071204004	4	-	48
1071204005	5	-	60
1071204006	6	-	72
1071204007	7	-	84
1071204008	8	-	96
1071204009	9	-	108
1071204010	10	-	120
1071204011	11	-	132
1071204012	12	-	144
1071204013	13	-	156
1071204014	14	-	168
1071204015	15	-	180
1071204016	16	-	192
1071204017	17	-	204
1071204018	18	-	216
1071204019	19	-	228
1071204020	20	-	240

Screws

- Ø 3.5 mm – Locking Self Tapping Screw
- Ø 3.5 mm – Cortical Self Tapping Screw
- Ø 4,0 mm – Locking Cancellous Screw

Thickness: 3
Width: 10

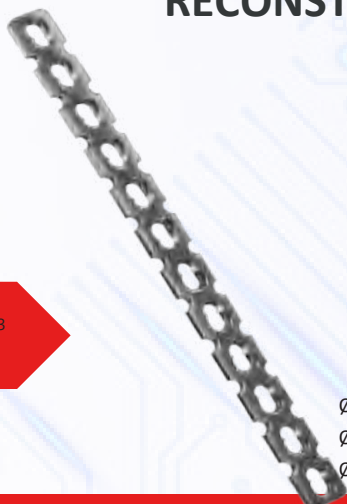

CALCANEUS LOCKING PLATE

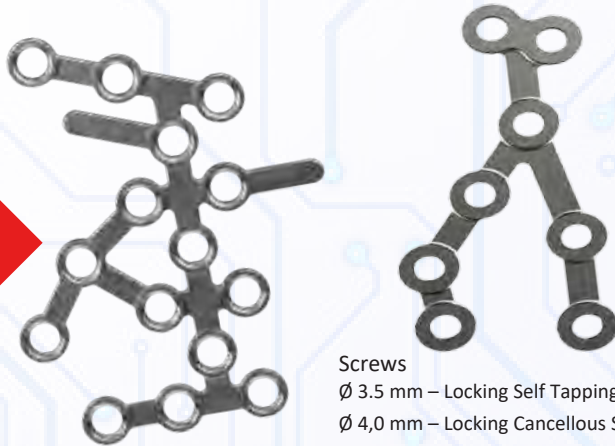

R

Thickness: 2
Width:

Code Holes Side Length

1091013508	8	R	60
1091013510	10	R	75
1091013515	15	R	69
1091013516	15	R	75
1091023508	8	L	60
1091023510	10	L	75
1091023515	15	L	69
1091023516	15	L	75

Screws

Ø 3.5 mm – Locking Self Tapping Screw

Ø 4,0 mm – Locking Cancellous Screw

SMALL FEMUR PROXIMAL HIP LOCKING PLATE

3.5

Code Holes Angle Length

1061103503	3	100	76
1061103513	3	110	76
1061103504	3	120	62
1061103506	6	120	114
1061103523	3	150	65

5.0

Code Hol Angle Length

2061105003	4	100	116
2061105013	4	110	117
2061105004	4	120	117
2061105006	6	120	149
2061105023	4	150	117



Thickness: 3,08
Width: 12,0

Thickness: 3,4
Width: 16,0

Ø 3.5 mm – Locking Self Tapping Screw
Ø 3.5 mm – Cortical Self Tapping Screw
Ø 5,0 mm – Locking Cancellous Screw
Ø 5,0 mm – Cancellous Screw
Ø 4.5 mm – Cortical Self Tapping Screw

PELVIC RECONSTRUCTION CURVED LOCKING PLATE



Thickness: 2,5
Width: 10

Code Holes Side Length

2061003504	4	-	47
2061003505	5	-	61
2061003506	6	-	73
2061003507	7	-	85
2061003508	8	-	97
2061003509	9	-	108
2061003510	10	-	119
2061003511	11	-	130
2061003512	12	-	141
2061003513	13	-	150
2061003514	14	-	157

Ø 3.5 mm – Locking Self Tapping Screw
Ø 3.5 mm – Cortical Self Tapping Screw
Ø 4,0 mm – Locking Cancellous Screw

PELVIC SYMPHYSEAL PLATE



Thickness: 2,5
Width: 10

Screws

- Ø 3.5 mm – Locking Self Tapping Screw
- Ø 3.5 mm – Cortical Self Tapping Screw
- Ø 4,0 mm – Locking Cancellous Screw

Code	Holes	Side	Length
2061003552	4	-	52
2061003555	4	-	55
2061003558	4	-	58

PELVIC RECONSTRUCTION STRAIGHT LOCKING PLATE

Code	Holes	Side	Length
2061013504	4	-	46
2061013505	5	-	58
2061013506	6	-	70
2061013507	7	-	82
2061013508	8	-	94
2061013509	9	-	106
2061013510	10	-	118
2061013511	11	-	130
2061013512	12	-	142
2061013513	13	-	154
2061013514	14	-	166
2061013515	15	-	178
2061013516	16	-	190



Thickness: 2,5
Width: 10

Screws

- Ø 3.5 mm – Locking Self Tapping Screw
- Ø 3.5 mm – Cortical Self Tapping Screw
- Ø 4,0 mm – Locking Cancellous Screw

EIGHT NON LOCKING PLATE



Thickness: 1,6
Width: 9,8

Screws

- Ø 3.5 mm – Cortical Self Tapping Screw
- Ø 3.5 mm – Cannulated Screw
- Ø 4,0 mm – Cancellous Screw
- Ø 4,5 mm – Full Tread Cannulated Screw

Code	Size	Side	Length
8880000050	STD.	-	26
8880000051	LONG	-	30

**LOCKING SELF TAPPING
CORTICAL SCREW Ø 1,5 MM**



**LOCKING SELF TAPPING
CORTICAL SCREW Ø 2,0 MM**



**LOCKING SELF TAPPING
CORTICAL SCREW Ø 2,5 MM**



Code Size

3001001506	6 mm
3001001507	7 mm
3001001508	8 mm
3001001509	9 mm
3001001510	10 mm
3001001511	11 mm
3001001512	12 mm
3001001513	13 mm
3001001514	14 mm
3001001515	15 mm
3001001516	16 mm
3001001517	17 mm
3001001518	18 mm
3001001519	19 mm
3001001520	20 mm
3001001522	22 mm
3001001524	24 mm
3001001526	26 mm
3001001528	28 mm
3001001530	30 mm

Code Size

3001002006	6 mm
3001002007	7 mm
3001002008	8 mm
3001002009	9 mm
3001002010	10 mm
3001002011	11 mm
3001002012	12 mm
3001002013	13 mm
3001002014	14 mm
3001002015	15 mm
3001002016	16 mm
3001002017	17 mm
3001002018	18 mm
3001002019	19 mm
3001002020	20 mm
3001002022	22 mm
3001002024	24 mm
3001002026	26 mm
3001002028	28 mm
3001002030	30 mm

Code Size

3001002506	6 mm
3001002507	7 mm
3001002508	8 mm
3001002509	9 mm
3001002510	10 mm
3001002511	11 mm
3001002512	12 mm
3001002513	13 mm
3001002514	14 mm
3001002515	15 mm
3001002516	16 mm
3001002517	17 mm
3001002518	18 mm
3001002519	19 mm
3001002520	20 mm
3001002522	22 mm
3001002524	24 mm
3001002526	26 mm
3001002528	28 mm
3001002530	30 mm
3001002532	32 mm
3001002534	34 mm
3001002536	36 mm
3001002538	38 mm
3001002540	40 mm

**LOCKING SELF TAPPING
CORTICAL SCREW Ø 2,7 MM**



**LOCKING SELF TAPPING
CORTICAL SCREW Ø 3,5 MM**



**LOCKING SELF TAPPING
CORTICAL SCREW Ø 5,0 MM**



Code	Size	Code	Size	Code	Size	Code	Size
3001002710	10 mm	3001003510	10 mm	3001005016	16 mm	3001005065	65 mm
3001002711	11 mm	3001003512	12 mm	3001005018	18 mm	3001005066	66 mm
3001002712	12 mm	3001003514	14 mm	3001005020	20 mm	3001005068	68 mm
3001002713	13 mm	3001003516	16 mm	3001005022	22 mm	3001005070	70 mm
3001002714	14 mm	3001003518	18 mm	3001005024	24 mm	3001005072	72 mm
3001002715	15 mm	3001003520	20 mm	3001005026	26 mm	3001005074	74 mm
3001002716	16 mm	3001003522	22 mm	3001005028	28 mm	3001005075	75 mm
3001002717	17 mm	3001003524	24 mm	3001005030	30 mm	3001005076	76 mm
3001002718	18 mm	3001003526	26 mm	3001005032	32 mm	3001005078	78 mm
3001002719	19 mm	3001003528	28 mm	3001005034	34 mm	3001005080	80 mm
3001002720	20 mm	3001003530	30 mm	3001005036	36 mm	3001005082	82 mm
3001002722	22 mm	3001003532	32 mm	3001005038	38 mm	3001005084	84 mm
3001002724	24 mm	3001003534	34 mm	3001005040	40 mm	3001005085	85 mm
3001002726	26 mm	3001003536	36 mm	3001005042	42 mm	3001005086	86 mm
3001002728	28 mm	3001003538	38 mm	3001005044	44 mm	3001005088	88 mm
3001002730	30 mm	3001003540	40 mm	3001005046	46 mm	3001005090	90 mm
3001002732	32 mm	3001003542	42 mm	3001005048	48 mm	3001005092	92 mm
3001002734	34 mm	3001003544	44 mm	3001005050	50 mm	3001005094	94 mm
3001002736	36 mm	3001003546	46 mm	3001005052	52 mm	3001005096	96 mm
3001002738	38 mm	3001003548	48 mm	3001005054	54 mm	3001005098	98 mm
3001002740	40 mm	3001003550	50 mm	3001005055	55 mm	3001005010	100 mm
3001002742	42 mm	3001003552	52 mm	3001005056	56 mm	3001005011	102 mm
3001002744	44 mm	3001003554	54 mm	3001005058	58 mm	3001005012	104 mm
3001002746	46 mm	3001003555	55 mm	3001005060	60 mm	3001005013	106 mm
3001002748	48 mm	3001003556	56 mm	3001005062	62 mm	3001005014	108 mm
3001002750	50 mm	3001003558	58 mm	3001005064	64 mm	3001005015	110 mm
		3001003560	60 mm				
		3001003565	65 mm				
		3001003570	70 mm				

**CORTICAL SELF TAPPING SCREW
Ø 1,5 MM**



**CORTICAL SELF TAPPING SCREW
Ø 2,0 MM**



**CORTICAL SELF TAPPING SCREW
Ø 2,5 MM**



Code Size

3002001506	6 mm
3002001507	7 mm
3002001508	8 mm
3002001509	9 mm
3002001510	10 mm
3002001511	11 mm
3002001512	12 mm
3002001513	13 mm
3002001514	14 mm
3002001515	15 mm
3002001516	16 mm
3002001517	17 mm
3002001518	18 mm
3002001519	19 mm
3002001520	20 mm
3002001522	22 mm
3002001524	24 mm
3002001526	26 mm
3002001528	28 mm
3002001530	30 mm

Code Size

3002002006	6 mm
3002002007	7 mm
3002002008	8 mm
3002002009	9 mm
3002002010	10 mm
3002002011	11 mm
3002002012	12 mm
3002002013	13 mm
3002002014	14 mm
3002002015	15 mm
3002002016	16 mm
3002002017	17 mm
3002002018	18 mm
3002002019	19 mm
3002002020	20 mm
3002002022	22 mm
3002002024	24 mm
3002002026	26 mm
3002002028	28 mm
3002002030	30 mm

Code Size

3002002506	6 mm
3002002507	7 mm
3002002508	8 mm
3002002509	9 mm
3002002510	10 mm
3002002511	11 mm
3002002512	12 mm
3002002513	13 mm
3002002514	14 mm
3002002515	15 mm
3002002516	16 mm
3002002517	17 mm
3002002518	18 mm
3002002519	19 mm
3002002520	20 mm
3002002522	22 mm
3002002524	24 mm
3002002526	26 mm
3002002528	28 mm
3002002530	30 mm
3002002532	32 mm
3002002534	34 mm
3002002536	36 mm
3002002538	38 mm
3002002540	40 mm

CORTICAL SELF TAPPING SCREW
Ø 2,7 MM



CORTICAL SELF TAPPING SCREW
Ø 3,5 MM



CORTICAL SELF TAPPING SCREW
Ø 4,5 MM



Code **Size**

3002002710	10 mm
3002002712	12 mm
3002002714	14 mm
3002002716	16 mm
3002002718	18 mm
3002002720	20 mm
3002002722	22 mm
3002002724	24 mm
3002002726	26 mm
3002002728	28 mm
3002002730	30 mm
3002002732	32 mm
3002002734	34 mm
3002002736	36 mm
3002002738	38 mm
3002002740	40 mm
3002002742	42 mm
3002002744	44 mm
3002002746	46 mm
3002002748	48 mm
3002002750	50 mm

Code **Size**

3002003510	10 mm
3002003512	12 mm
3002003514	14 mm
3002003516	16 mm
3002003518	18 mm
3002003520	20 mm
3002003522	22 mm
3002003524	24 mm
3002003526	26 mm
3002003528	28 mm
3002003530	30 mm
3002003532	32 mm
3002003534	34 mm
3002003536	36 mm
3002003538	38 mm
3002003540	40 mm
3002003542	42 mm
3002003544	44 mm
3002003545	45 mm
3002003546	46 mm
3002003548	48 mm
3002003550	50 mm
3002003555	55 mm
3002003560	60 mm
3002003565	65 mm
3002003570	70 mm
3002003575	75 mm
3002003580	80 mm
3002003585	85 mm
3002003590	90 mm

Code **Size**

3002004514	14 mm
3002004516	16 mm
3002004518	18 mm
3002004520	20 mm
3002004522	22 mm
3002004524	24 mm
3002004526	26 mm
3002004528	28 mm
3002004530	30 mm
3002004532	32 mm
3002004534	34 mm
3002004536	36 mm
3002004538	38 mm
3002004540	40 mm
3002004542	42 mm
3002004544	44 mm
3002004546	46 mm
3002004548	48 mm
3002004550	50 mm
3002004552	52 mm
3002004554	54 mm
3002004555	55 mm
3002004556	56 mm
3002004558	58 mm
3002004560	60 mm
3002004562	62 mm
3002004564	64 mm
3002004565	65 mm
3002004566	66 mm
3002004568	68 mm
3002004570	70 mm

**LOCKING CANCELLOUS/
SPONGIOSE SCREW Ø 4,0 MM**



Code	Size
3008034010	10 mm
3008034012	12 mm
3008034014	14 mm
3008034016	16 mm
3008034018	18 mm
3008034020	20 mm
3008034022	22 mm
3008034024	24 mm
3008034026	26 mm
3008034028	28 mm
3008034030	30 mm
3008034035	35 mm
3008034040	40 mm
3008034045	45 mm
3008034050	50 mm
3008034055	55 mm
3008034060	60 mm
3008034065	65 mm
3008034070	70 mm
3008034075	75 mm

**LOCKING CANCELLOUS/
SPONGIOSE SCREW Ø 5,0 MM**



Code	Size	Code	Size
3008035020	20 mm	3008035066	66 mm
3008035022	22 mm	3008035068	68 mm
3008035024	24 mm	3008035070	70 mm
3008035026	26 mm	3008035072	72 mm
3008035028	28 mm	3008035074	74 mm
3008035030	30 mm	3008035075	75 mm
3008035032	32 mm	3008035076	76 mm
3008035034	34 mm	3008035078	78 mm
3008035036	36 mm	3008035080	80 mm
3008035038	38 mm	3008035082	82 mm
3008035040	40 mm	3008035084	84 mm
3008035042	42 mm	3008035085	85 mm
3008035044	44 mm	3008035086	86 mm
3008035046	46 mm	3008035088	88 mm
3008035048	48 mm	3008035090	90 mm
3008035050	50 mm	3008035092	92 mm
3008035052	52 mm	3008035094	94 mm
3008035054	54 mm	3008035096	96 mm
3008035055	55 mm	3008035098	98 mm
3008035056	56 mm	3008035010	100 mm
3008035058	58 mm	3008035011	102 mm
3008035060	60 mm	3008035012	104 mm
3008035062	62 mm	3008035013	106 mm
3008035064	64 mm	3008035014	108 mm
3008035065	65 mm	3008035015	110 mm

**CANCELLOUS/SPONGIOSE SCREW FULL THREAD
Ø 4,0 MM**



Code	Size
3003034010	10 mm
3003034012	12 mm
3003034014	14 mm
3003034016	16 mm
3003034018	18 mm
3003034020	20 mm
3003034022	22 mm
3003034024	24 mm
3003034026	26 mm
3003034028	28 mm
3003034030	30 mm
3003034032	32 mm
3003034034	34 mm
3003034036	36 mm
3003034038	38 mm
3003034040	40 mm
3003034045	45 mm
3003034050	50 mm
3003034055	55 mm
3003034060	60 mm
3003034065	65 mm
3003034070	70 mm

**CANCELLOUS/SPONGIOSE SCREW FULL THREAD
Ø 6,5 MM**



Code	Size
3003036530	30 mm
3003036535	35 mm
3003036540	40 mm
3003036545	45 mm
3003036550	50 mm
3003036555	55 mm
3003036560	60 mm
3003036565	65 mm
3003036570	70 mm
3003036575	75 mm
3003036580	80 mm
3003036585	85 mm
3003036590	90 mm
3003036595	95 mm
3003036510	100 mm
3003036515	105 mm
3003036511	110 mm
3003036516	115 mm
3003036512	120 mm

**CANCELLOUS SCREW HALF
THREAD Ø 4,0 MM**



Code	Size
3003044030	30 mm
3003044035	35 mm
3003044040	40 mm
3003044045	45 mm
3003044050	50 mm
3003044055	55 mm
3003044060	60 mm
3003044065	65 mm
3003044070	70 mm

**CANCELLOUS SCREW 16 MM
HALF THREAD Ø 6,5 MM**



Code	Size
3003046545	45 mm
3003046550	50 mm
3003046555	55 mm
3003046560	60 mm
3003046565	65 mm
3003046570	70 mm
3003046575	75 mm
3003046580	80 mm
3003046585	85 mm
3003046590	90 mm
3003046595	95 mm
3003046510	100 mm
3003046515	105 mm
3003046511	110 mm
3003046516	115 mm
3003046512	120 mm

**CANCELLOUS SCREW 32 MM
THREAD Ø 6,5 MM**



Code	Size
3003047545	45 mm
3003047550	50 mm
3003047555	55 mm
3003047560	60 mm
3003047565	65 mm
3003047570	70 mm
3003047575	75 mm
3003047580	80 mm
3003047585	85 mm
3003047590	90 mm
3003047595	95 mm
3003047600	100 mm
3003047605	105 mm
3003047610	110 mm
3003047615	115 mm
3003047620	120 mm

**CANNULATED COMPRESSION
SCREW Ø 2,7 MM**



Code	Size
3004032720	20 mm
3004032722	22 mm
3004032724	24 mm
3004032726	26 mm
3004032728	28 mm
3004032730	30 mm
3004032732	32 mm
3004032734	34 mm
3004032736	36 mm
3004032738	38 mm
3004032740	40 mm
3004032742	42 mm
3004032744	44 mm
3004032746	46 mm
3004032748	48 mm
3004032750	50 mm

**CANNULATED COMPRESSION
SCREW FULL THREAD Ø 2,7 MM**

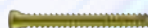

Code	Size
3004044520	20 mm
3004044522	22 mm
3004044524	24 mm
3004044526	26 mm
3004044528	28 mm
3004044530	30 mm
3004044532	32 mm
3004044534	34 mm
3004044536	36 mm
3004044538	38 mm
3004044540	40 mm
3004044545	45 mm
3004044550	50 mm
3004044555	55 mm
3004044560	60 mm
3004044565	65 mm
3004044570	70 mm
3004044575	75 mm
3004044580	80 mm

**CANNULATED COMPRESSION
SCREW Ø 3,5 MM**



Code	Size
3004033520	20 mm
3004033522	22 mm
3004033524	24 mm
3004033526	26 mm
3004033528	28 mm
3004033530	30 mm
3004033532	32 mm
3004033534	34 mm
3004033536	36 mm
3004033538	38 mm
3004033540	40 mm
3004033542	42 mm
3004033544	44 mm
3004033546	46 mm
3004033548	48 mm
3004033550	50 mm

CANNULATED COMPRESSION SCREW
Ø 4,5 MM



Code	Size
3004034525	25 mm
3004034530	30 mm
3004034535	35 mm
3004034540	40 mm
3004034545	45 mm
3004034550	50 mm
3004034555	55 mm
3004034560	60 mm
3004034565	65 mm
3004034570	70 mm
3004034575	75 mm
3004034580	80 mm
3004034585	85 mm
3004034590	90 mm

CANNULATED COMPRESSION SCREW
16 MM THREAD Ø 6,5 MM



Code	Size
3004036550	50 mm
3004036555	55 mm
3004036560	60 mm
3004036565	65 mm
3004036570	70 mm
3004036575	75 mm
3004036580	80 mm
3004036585	85 mm
3004036590	90 mm
3004036595	95 mm
3004036100	100 mm
3004036105	105 mm
3004036110	110 mm
3004036115	115 mm
3004036120	120 mm

CANNULATED COMPRESSION SCREW
32 MM THREAD Ø 6,5 MM



Code	Size
3004036645	45 mm
3004036650	50 mm
3004036655	55 mm
3004036660	60 mm
3004036665	65 mm
3004036670	70 mm
3004036675	75 mm
3004036680	80 mm
3004036685	85 mm
3004036690	90 mm
3004036695	95 mm
3004036700	100 mm
3004036705	105 mm
3004036710	110 mm
3004036715	115 mm
3004036720	120 mm

CANNULATED COMPRESSION SCREW
16 MM THREAD Ø 7,3 MM

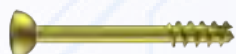

Code	Size
3004037350	50 mm
3004037355	55 mm
3004037360	60 mm
3004037365	65 mm
3004037370	70 mm
3004037375	75 mm
3004037380	80 mm
3004037385	85 mm
3004037390	90 mm
3004037395	95 mm
3004037100	100 mm
3004037105	105 mm
3004037110	110 mm
3004037115	115 mm
3004037120	120 mm

CANNULATED COMPRESSION SCREW
32 MM THREAD Ø 7,3 MM



Code	Size
3004047345	45 mm
3004047350	50 mm
3004047355	55 mm
3004047360	60 mm
3004047365	65 mm
3004047370	70 mm
3004047375	75 mm
3004047380	80 mm
3004047385	85 mm
3004047390	90 mm
3004047395	95 mm
3004047400	100 mm
3004047405	105 mm
3004047410	110 mm
3004047415	115 mm

**LOCKING CANNULATED
FULL THREAD SCREW Ø 2,5 MM**



Code Size

3005032506	6 mm
3005032507	7 mm
3005032508	8 mm
3005032509	9 mm
3005032510	10 mm
3005032511	11 mm
3005032512	12 mm
3005032513	13 mm
3005032514	14 mm
3005032515	15 mm
3005032516	16 mm
3005032517	17 mm
3005032518	18 mm
3005032519	19 mm
3005032520	20 mm
3005032522	22 mm
3005032524	24 mm
3005032526	26 mm
3005032528	28 mm
3005032530	30 mm

**LOCKING CANNULATED
FULL THREAD SCREW Ø 3,5 MM**



Code Size

3005033510	10 mm
3005033512	12 mm
3005033514	14 mm
3005033516	16 mm
3005033518	18 mm
3005033520	20 mm
3005033522	22 mm
3005033524	24 mm
3005033526	26 mm
3005033528	28 mm
3005033530	30 mm
3005033532	32 mm
3005033534	34 mm
3005033536	36 mm
3005033538	38 mm
3005033540	40 mm
3005033542	42 mm
3005033544	44 mm
3005033546	46 mm
3005033548	48 mm
3005033550	50 mm
3005033554	54 mm
3005033555	55 mm
3005033556	56 mm
3005033558	58 mm
3005033560	60 mm

**LOCKING CANNULATED FULL
THREAD SCREW Ø 5,0 MM**



Code Size Code Size

3005035016	16 mm	3005035065	65 mm
3005035018	18 mm	3005035066	66 mm
3005035020	20 mm	3005035068	68 mm
3005035022	22 mm	3005035070	70 mm
3005035024	24 mm	3005035072	72 mm
3005035026	26 mm	3005035074	74 mm
3005035028	28 mm	3005035075	75 mm
3005035030	30 mm	3005035076	76 mm
3005035032	32 mm	3005035078	78 mm
3005035034	34 mm	3005035080	80 mm
3005035036	36 mm	3005035082	82 mm
3005035038	38 mm	3005035084	84 mm
3005035040	40 mm	3005035085	85 mm
3005035042	42 mm	3005035086	86 mm
3005035044	44 mm	3005035088	88 mm
3005035046	46 mm	3005035090	90 mm
3005035048	48 mm	3005035092	92 mm
3005035050	50 mm	3005035094	94 mm
3005035052	52 mm	3005035096	96 mm
3005035054	54 mm	3005035098	98 mm
3005035055	55 mm	3005035010	100 mm
3005035056	56 mm	3005035011	102 mm
3005035058	58 mm	3005035012	104 mm
3005035060	60 mm	3005035013	106 mm
3005035062	62 mm	3005035014	108 mm
3005035064	64 mm	3005035015	110 mm

**LOCKING CANNULATED FULL
THREAD SCREW Ø 6,5 MM**



Code Size WASHER

3005006550	50 mm
3005006555	55 mm
3005006560	60 mm
3005006565	65 mm
3005006570	70 mm
3005006575	75 mm
3005006580	80 mm
3005006585	85 mm
3005006590	90 mm
3005006595	95 mm
3005006100	100 mm
3005006105	105 mm
3005006110	110 mm
3005006115	115 mm
3005006120	120 mm



Code Size

4007000100	S(3,5)
4007000101	M(4,5)
4007000102	L(6,5&7,3)
4007000103	XL(6,5&7,3)
4007000104	XXL(6,5&7,3)

**HEADLESS CANNULATED
FULL THREAD SCREW Ø 2,5 MM**



Code	Size
3009032008	8 mm
3009032012	10 mm
3009032014	12 mm
3009032016	14 mm
3009032018	16 mm
3009032020	18 mm
3009032022	20 mm
3009032024	22 mm
3009032026	24 mm
3009032028	26 mm
3009032030	28 mm
3009032010	30 mm

**HEADLESS CANNULATED
FULL THREAD SCREW Ø 3,5 MM**



Code	Size
3009032708	12 mm
3009032710	14 mm
3009032712	16 mm
3009032714	18 mm
3009032716	20 mm
3009032718	22 mm
3009032720	24 mm
3009032722	26 mm
3009032724	28 mm
3009032726	30 mm
3009032728	32 mm
3009032730	34 mm
3009033512	36 mm
3009033514	38 mm
3009033516	40 mm
3009033518	42 mm

**HEADLESS CANNULATED
FULL THREAD SCREW Ø 4,0 MM**



Code	Size
3009033520	20 mm
3009033522	22 mm
3009033524	24 mm
3009033526	26 mm
3009033528	28 mm
3009033530	30 mm
3009033532	32 mm
3009033534	34 mm
3009033536	36 mm
3009033538	38 mm
3009033540	40 mm
3009033542	45 mm
3009033544	50 mm
3009033546	55 mm
3009033548	60 mm
3009033550	65 mm
3009034070	70 mm

**HEADLESS CANNULATED
FULL THREAD SCREW Ø 5,0 MM**



Code	Size	Code	Size
3009035020	20 mm	3009035065	65 mm
3009035025	25 mm	3009035070	70 mm
3009035030	30 mm	3009035075	75 mm
3009035035	35 mm	3009035080	80 mm
3009035040	40 mm	3009035085	85 mm
3009035045	45 mm	3009035090	90 mm
3009035050	50 mm	3009035095	95 mm
3009035055	55 mm	3009035100	100 mm
3009035060	60 mm		

**HERBERT SCREW
Ø 5,0 MM**

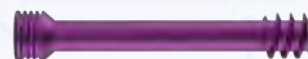

**HERBERT SCREW
Ø 2,5 MM**



Code	Size
3009042508	8 mm
3009042509	9 mm
3009042510	10 mm
3009042512	12 mm
3009042514	14 mm
3009042516	16 mm
3009042518	18 mm
3009042520	20 mm
3009042522	22 mm
3009042524	24 mm
3009042526	26 mm
3009042528	28 mm
3009042530	30 mm

**HERBERT SCREW
Ø 3,0 MM**



Code	Size
3009043008	8 mm
3009043010	10 mm
3009043012	12 mm
3009043014	14 mm
3009043016	16 mm
3009043018	18 mm
3009043020	20 mm
3009043022	22 mm
3009043024	24 mm
3009043026	26 mm
3009043028	28 mm
3009043030	30 mm
3009043032	32 mm

Code	Size
3009045020	20 mm
3009045022	22 mm
3009045024	24 mm
3009045026	26 mm
3009045028	28 mm
3009045030	30 mm
3009045032	32 mm
3009045034	34 mm
3009045036	36 mm
3009045038	38 mm
3009045040	40 mm
3009045045	45 mm
3009045050	50 mm
3009045055	55 mm
3009045060	60 mm
3009045065	65 mm
3009045070	70 mm

CABLE LOCKING SCREW



Code	Size
3007035002	5 mm

CAP SCREW



Code	Size
3007032500	L(2,5)
3007032501	S(2,5)
3007033500	L(3,5)
3007033501	S(3,5)
3007035000	L(5,0)
3007035001	S(5,0)

1,5 MM HAND / FOOT MINI LOCKING PLATE SERIES

1,5 Mini Locking Straight Plate

Code	Holes	Side	Thickness
1051001501	4	-	1,2
1051001502	5	-	1,2
1051001503	6	-	1,2
1051001504	8	-	1,2



1,5 Mini Locking T Plate Head 2 Holes

Code	Holes	Side	Thickness
1051001505	4	-	1,2
1051001506	8	-	1,2



1,5 Mini Locking H Plate

Code	Holes	Side	Thickness
1052001501	-	-	1,2



Specification

Mini Plate Set
Hand/Foot plate
Intended Use : 1.5 mm mini locking plates are intended for temporary fixation, correction or stabilization of bones in anatomical region of the hand.

1,5 Mini Locking T Plate Head 3 Holes

Code	Holes	Side	Thickness
1051001507	4	-	1,2
1051001508	8	-	1,2



Indications

Fracture fixation of the phalanges and metacarpals
Osteotomies
Arthrodesis
Replantations and reconstructions of phalanges and metacarpals, particularly in osteopenic bone

1,5 Mini Locking T Plate Head 4 Holes

Code	Holes	Side	Thickness
1051002407	6	-	1,2



1,5 Mini Locking Y Plate

Code	Holes	Side	Thickness
1051001509	4	-	1,2
1051001510	8	-	1,2



1,5 Mini Locking Condylar Plate

Code	Holes	Side	Thickness
1051001511	4	-	1,2
1051001512	8	-	1,2

Specification

Mini Plate Set
Hand/Foot plate
Intended Use : 1.5 mm mini locking plates are intended for temporary fixation, correction or stabilization of bones in anatomical region of the hand.



Indications

Fracture fixation of the phalanges and metacarpals
Osteotomies
Arthrodesis
Replantations and reconstructions of phalanges and metacarpals, particularly in osteopenic bone

1,5 MM HAND / FOOT MINI LOCKING PLATE SERIES

1,5 Mini Non-Locking Strut Plate

Code	Holes	Side	Thickness
1051021513	8	L	1,0
1051011514	8	R	1,0

R



1,5 Mini Non-Locking Straight Plate

Code	Holes	Side	Thickness
1052001502	14	-	1,0



1.5 Mini Non-locking Mallet Finger Plate

Code	Holes	Side	Thickness
1052001500	2	- -	1,0



Specification

Mini Plate Set
Hand/Foot plate
Intended Use : 1.5 mm mini locking plates are intended for temporary fixation, correction or stabilization of bones in anatomical region of the hand.

1,5 Mini Non-Locking T Plate Head 4 Holes

Code	Holes	Side	Thickness
1051002406	6	-	1,0



Indications

Fracture fixation of the phalanges and metacarpals
Osteotomies
Arthrodesis
Replantations and reconstructions of phalanges and metacarpals, particularly in osteopenic bone

LOCKING SELF TAPPING SCREW Ø1,5 MM



Code	Size
3001001506	6 mm
3001001507	7 mm
3001001508	8 mm
3001001509	9 mm
3001001510	10 mm
3001001511	11 mm
3001001512	12 mm
3001001513	13 mm
3001001514	14 mm
3001001515	15 mm
3001001516	16 mm
3001001517	17 mm
3001001518	18 mm
3001001519	19 mm
3001001520	20 mm
3001001522	22 mm
3001001524	24 mm
3001001526	26 mm
3001001528	28 mm
3001001530	30 mm

CORTICAL SELF TAPPING SCREW Ø1,5 MM



Code	Size
3002001506	6 mm
3002001507	7 mm
3002001508	8 mm
3002001509	9 mm
3002001510	10 mm
3002001511	11 mm
3002001512	12 mm
3002001513	13 mm
3002001514	14 mm
3002001515	15 mm
3002001516	16 mm
3002001517	17 mm
3002001518	18 mm
3002001519	19 mm
3002001520	20 mm
3002001522	22 mm
3002001524	24 mm
3002001526	26 mm
3002001528	28 mm
3002001530	30 mm

2,0 MM HAND / FOOT MINI LOCKING PLATE SERIES

2.0 Mini Locking Straight Plate

Code	Holes	Side	Thickness
1051002000	4	-	1,5
1051002001	5	-	1,5
1051002002	6	-	1,5
1051002003	7	-	1,5
1051002004	8	-	1,5



2,0 Mini Locking T Plate Head 2 Holes

Code	Holes	Side	Thickness
1051002007	3	-	1,2
1051002008	5	-	1,2
1051002009	7	-	1,2



2,0 Mini Locking Condylar Plate

Code	Holes	Side	Thickness
1051002013	3	-	1,2
1051002014	5	-	1,2
1051002015	7	-	1,2



Specification

Mini Plate Set
Hand/Foot plate
Intended Use : 2.0 mm mini locking plates are intended for temporary fixation, correction or stabilization of bones in anatomical region of the hand.

2,0 Mini Locking Y Plate Head 3 Holes

Code	Holes	Side	Thickness
1051002010	3	-	1,2
1051002011	5	-	1,2
1051002012	7	-	1,2



Indications

Fracture fixation of the phalanges and metacarpals
Osteotomies
Arthrodesis
Replantations and reconstructions of phalanges and metacarpals, particularly in osteopenic bone

2.0 Mini Adaptation T Plate

Code	Holes	Side	Thickness
1051002016	3	- -	1,2
1051002017	5	-	1,2
1051002018	7	-	1,2



2.0 Mini Adaptation Straight Plate

Code	Holes	Side	Thickness
1051002005	6	-	1,2
1051002006	12	-	1,2



2,0 MM HAND / FOOT MINI LOCKING PLATE SERIES

LOCKING SELF TAPPING SCREW Ø2,0 MM



Code Size

3001002006	6 mm
3001002007	7 mm
3001002008	8 mm
3001002009	9 mm
3001002010	10 mm
3001002011	11 mm
3001002012	12 mm
3001002013	13 mm
3001002014	14 mm
3001002015	15 mm
3001002016	16 mm
3001002017	17 mm
3001002018	18 mm
3001002019	19 mm
3001002020	20 mm
3001002022	22 mm
3001002024	24 mm
3001002026	26 mm
3001002028	28 mm
3001002030	30 mm

CORTICAL SELF TAPPING SCREW Ø2,0 MM



Code Size

3002002006	6 mm
3002002007	7 mm
3002002008	8 mm
3002002009	9 mm
3002002010	10 mm
3002002011	11 mm
3002002012	12 mm
3002002013	13 mm
3002002014	14 mm
3002002015	15 mm
3002002016	16 mm
3002002017	17 mm
3002002018	18 mm
3002002019	19 mm
3002002020	20 mm
3002002022	22 mm
3002002024	24 mm
3002002026	26 mm
3002002028	28 mm
3002002030	30 mm

2,5 MM HAND / FOOT MINI LOCKING PLATE SERIES

2,5 Mini Locking H Plate

Code Holes Side Thickness

1051002517	5	-	1,5
1051002518	8	-	1,5



2,5 Mini Locking T Plate

Code Holes Side Thickness

1051002519	3	-	1,3
1051002520	5	-	1,3
1051002521	7	-	1,3



2,5 MM HAND / FOOT MINI LOCKING PLATE SERIES

2.5 Mini Locking Straight Plate

Code	Holes	Side	Thickness
1051002500	4	-	2,5
1051002501	5	-	2,5
1051002502	6	-	2,5
1051002503	7	-	2,5
1051002504	8	-	2,5
1051002505	10	-	2,5



Specification

Mini Plate Set
Hand/Foot plate
Intended Use : 2.5 mm mini locking plates are intended for temporary fixation, correction or stabilization of bones in anatomical region of the hand.

2,5 Mini Locking T Plate Head 2 Holes

Code	Holes	Side	Thickness
1051002408	3	-	1,3
1051002409	5	-	1,3
1051002410	7	-	1,3



Indications

Fracture fixation of the phalanges and metacarpals
Osteotomies
Arthrodesis
Replantations and reconstructions of phalanges and metacarpals, particularly in osteopenic bone

2,5 Mini Locking Straight Plate

	Holes	Side	Thickness
1051002400	4	-	2,0
1051002401	5	-	2,0
1051002402	6	-	2,0
1051002403	7	-	2,0
1051002404	8	-	2,0
1051002405	10	-	2,0



2,5 Mini Locking T Plate Head 3 Holes

Code	Holes	Side	Thickness
1051002411	3	-	1,5
1051002412	5	-	1,5
1051002413	7	-	1,5



2,5 Mini Locking L Plate

Code	Holes	Side	Thickness
1051002421	3	R	1,5
1051002511	4	R	1,5
1051002512	3	L	1,5
1051002513	4	L	1,5

R



Specification

Mini Plate Set
Hand/Foot plate
Intended Use : 2.5 mm mini locking plates are intended for temporary fixation, correction or stabilization of bones in anatomical region of the hand.

2,5 Mini Adaptation Locking Straight Plate

Code	Holes	Side	Thickness
1051002506	6	-	1,6
1051002507	12	-	1,6



Indications

Fracture fixation of the phalanges and metacarpals
Osteotomies
Arthrodesis
Replantations and reconstructions of phalanges and metacarpals, particularly in osteopenic bone

2,5 MM HAND / FOOT MINI LOCKING PLATE SERIES

2,5 Mini Locking L Plate Oblique

Code	Holes	Side	Thickness
1051002417	3	R	1,5
1051002418	4	R	1,5
1051002419	3	L	1,5
1051002420	4	L	1,5

R



2,5 Mini Locking Condylar Plate

Code	Holes	Side	Thickness
1051002514	3	-	1,3
1051002515	5	-	1,3
1051002516	7	-	1,3



2,5 Foot Locking X Plate

Code	Holes	Size	Thickness
1051002414	4	S	1,5
1051002415	4	M	1,5
1051002416	4	L	1,5



Specification

Mini Plate Set

Hand/Foot plate

Intended Use : 2.5 mm mini locking plates are intended for temporary fixation, correction or stabilization of bones in anatomical region of the hand.

Indications

Fracture fixation of the phalanges and metacarpals
Osteotomies Arthrodesis Replantations and reconstructions of phalanges and metacarpals, particularly in osteopenic bone

LOCKING SELF TAPPING SCREW Ø2,5 MM



Code	Size
3001002506	6 mm
3001002507	7 mm
3001002508	8 mm
3001002509	9 mm
3001002510	10 mm
3001002511	11 mm
3001002512	12 mm
3001002513	13 mm
3001002514	14 mm
3001002515	15 mm
3001002516	16 mm
3001002517	17 mm
3001002518	18 mm
3001002519	19 mm
3001002520	20 mm
3001002522	22 mm
3001002524	24 mm
3001002526	26 mm
3001002528	28 mm
3001002530	30 mm
3001002532	32 mm
3001002534	34 mm
3001002536	36 mm
3001002538	38 mm
3001002540	40 mm

CORTICAL SELF TAPPING SCREW Ø2,5 MM



Code	Size
3002002506	6 mm
3002002507	7 mm
3002002508	8 mm
3002002509	9 mm
3002002510	10 mm
3002002511	11 mm
3002002512	12 mm
3002002513	13 mm
3002002514	14 mm
3002002515	15 mm
3002002516	16 mm
3002002517	17 mm
3002002518	18 mm
3002002519	19 mm
3002002520	20 mm
3002002522	22 mm
3002002524	24 mm
3002002526	26 mm
3002002528	28 mm
3002002530	30 mm
3002002532	32 mm
3002002534	34 mm
3002002536	36 mm
3002002538	38 mm
3002002540	40 mm

2,7 MM HAND / FOOT MINI LOCKING PLATE SERIES

2.7 Mini Locking Straight Plate

Code	Holes	Side	Thickness
1051002724	2	-	2,5
1051002700	4	-	2,5
1051002701	5	-	2,5
1051002702	6	-	2,5
1051002703	7	-	2,5
1051002704	8	-	2,5
1051002705	10	-	2,5



2,7 Foot Locking X Plate

Code	Holes	Side	Thickness
1051002721	4	S	1,8
1051002722	4	M	1,8
1051002723	4	L	1,8



2,7 Mini Locking H Plate

Code	Holes	Side	Thickness
1051002725	5	-	1,8
1051002726	8	-	1,8



2,7 Mini Locking Condylar Plate

Code	Holes	Side	Thickness
1051002718	3	-	1,8
1051002719	5	-	1,8
1051002720	7	-	1,8



Specification

Mini Plate Set
Hand/Foot plate
Intended Use : 2.7 mm mini locking plates are intended for temporary fixation, correction or stabilization of bones in anatomical region of the hand.

Indications

Fracture fixation of the phalanges and metacarpals
Osteotomies
Arthrodesis
Replantations and reconstructions of phalanges and metacarpals, particularly in osteopenic bone

2,7 MM HAND / FOOT MINI LOCKING PLATE SERIES

2,7 Mini Locking L Plate

Code	Holes	Side	Thickness
1051012716	3	R	1,8
1051012717	4	R	1,8
1051022714	3	L	1,8
1051022715	4	L	1,8

R



2,7 Mini Locking T Plate

Code	Holes	Side	Thickness
1051002708	3	-	1,8
1051002709	4	-	1,8

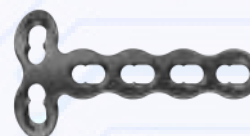

2,7 Mini Locking L Plate Oblique

Code	Holes	Side	Thickness
1051012712	3	R	1,8
1051012713	4	R	1,8
1051022710	3	L	1,8
1051022711	4	L	1,8

R



Specification

Mini Plate Set
Hand/Foot plate
Intended Use : 2.7 mm mini locking plates are intended for temporary fixation, correction or stabilization of bones in anatomical region of the hand.

2,7 Mini Adaptation Locking Straight Plate

Code	Holes	Side	Thickness
1051002706	6	-	1,8
1051002707	12	-	1,8



Indications

Fracture fixation of the phalanges and metacarpals
Osteotomies
Arthrodesis
Replantations and reconstructions of phalanges and metacarpals, particularly in osteopenic bone

LOCKING SELF TAPPING SCREW Ø2,7 MM







CORTICAL SELF TAPPING SCREW Ø2,7 MM



Code	Size	Code	Size	Code	Size
3001002710	10 mm	3001002742	42 mm	3002002710	10 mm
3001002711	11 mm	3001002744	44 mm	3002002712	12 mm
3001002712	12 mm	3001002746	46 mm	3002002714	14 mm
3001002713	13 mm	3001002748	48 mm	3002002716	16 mm
3001002714	14 mm	3001002750	50 mm	3002002718	18 mm
3001002715	15 mm			3002002720	20 mm
3001002716	16 mm			3002002722	22 mm
3001002717	17 mm			3002002724	24 mm
3001002718	18 mm			3002002726	26 mm
3001002719	19 mm			3002002728	28 mm
3001002720	20 mm			3002002730	30 mm
3001002722	22 mm			3002002732	32 mm
3001002724	24 mm			3002002734	34 mm
3001002726	26 mm			3002002736	36 mm
3001002728	28 mm			3002002738	38 mm
3001002730	30 mm			3002002740	40 mm
3001002732	32 mm			3002002742	42 mm
3001002734	34 mm			3002002744	44 mm
3001002736	36 mm			3002002746	46 mm
3001002738	38 mm			3002002748	48 mm
3001002740	40 mm			3002002750	50 mm

METACARPAL / METATARSAL FUSION PLATE SERIES

Code	Product Description	Angle	Side	Thickness	
1061202501	Metacarpal Fusion Plate Narrow	-	-	2	
1061202502	Metacarpal Fusion Plate Broad	-	-	2	
1091010200	Mini Foot Metatarsal Fusion Plate	0	R	2	
1091010201	Mini Foot Metatarsal Fusion Plate	5	R	2	
1091010202	Mini Foot Metatarsal Fusion Plate	15	R	2	
1091020203	Mini Foot Metatarsal Fusion Plate	0	L	2	
1091020204	Mini Foot Metatarsal Fusion Plate	5	L	2	
1091020205	Mini Foot Metatarsal Fusion Plate	15	L	2	

Specification
Mini Plate Set
Hand/Foot plate

Indications
Fractures of metatarsal
Fractures of the tarsals
MTP 1 fusions
Osteotomies and arthrodesis of the tarsals

R

LOCKING SELF TAPPING SCREW Ø2,5 MM



CORTICAL SELF TAPPING SCREW Ø2,5 MM



Code	Size	Code	Size	Code	Size	Code	Size
3001002506	6 mm	3001002524	24 mm	3002002506	6 mm	3002002524	24 mm
3001002507	7 mm	3001002526	26 mm	3002002507	7 mm	3002002526	26 mm
3001002508	8 mm	3001002528	28 mm	3002002508	8 mm	3002002528	28 mm
3001002509	9 mm	3001002530	30 mm	3002002509	9 mm	3002002530	30 mm
3001002510	10 mm	3001002532	32 mm	3002002510	10 mm	3002002532	32 mm
3001002511	11 mm	3001002534	34 mm	3002002511	11 mm	3002002534	34 mm
3001002512	12 mm	3001002536	36 mm	3002002512	12 mm	3002002536	36 mm
3001002513	13 mm	3001002538	38 mm	3002002513	13 mm	3002002538	38 mm
3001002514	14 mm	3001002540	40 mm	3002002514	14 mm	3002002540	40 mm
3001002515	15 mm			3002002515	15 mm		
3001002516	16 mm			3002002516	16 mm		
3001002517	17 mm			3002002517	17 mm		
3001002518	18 mm			3002002518	18 mm		
3001002519	19 mm			3002002519	19 mm		
3001002520	20 mm			3002002520	20 mm		
3001002522	22 mm			3002002522	22 mm		

NAIL SYSTEM

HUMERUS CANNULATED NAIL

Code	Size	Length
5024207160	7 mm	160
5024207185	7 mm	180
5024207200	7 mm	200
5024207215	7 mm	220
5024207245	7 mm	240
5024207260	7 mm	260
5024207275	7 mm	280
5024207305	7 mm	300
5024207320	7 mm	320
5024208160	8 mm	160
5024208185	8 mm	180
5024208200	8 mm	200
5024208215	8 mm	220
5024208245	8 mm	240
5024208260	8 mm	260
5024208275	8 mm	280
5024208305	8 mm	300
5024208320	8 mm	320
5024209160	9 mm	160
5024209185	9 mm	180
5024209200	9 mm	200
5024209215	9 mm	220
5024209245	9 mm	240
5024209260	9 mm	260
5024209275	9 mm	280
5024209305	9 mm	300
5024209320	9 mm	320



Humerus Locking Screw

Code	Size	Length
5026230020	5 mm	20
5026230025	5 mm	25
5026230030	5 mm	30
5026230035	5 mm	35
5026230040	5 mm	40
5026230045	5 mm	45
5026230050	5 mm	50
5026230055	5 mm	55
5026230060	5 mm	60
5026230065	5 mm	65
5026230070	5 mm	70
5026230075	5 mm	75
5026230080	5 mm	80



Humerus Locking Screw

Code	Size	Length
5026235020	3,5 mm	20
5026235025	3,5 mm	25
5026235030	3,5 mm	30
5026235035	3,5 mm	35
5026235040	3,5 mm	40
5026235045	3,5 mm	45
5026235050	3,5 mm	50
5026235055	3,5 mm	55
5026235060	3,5 mm	60
5026235065	3,5 mm	65
5026235070	3,5 mm	70
5026235075	3,5 mm	75
5026235080	3,5 mm	80



Indications

Stable or unstable fresh fractures, Pathologic fractures, Refractures, delayed unions and pseudarthrosis.

Humerus End Cap

Code	Size
5027030000	0
5026230005	5 mm
5026230010	10 mm



NAIL SYSTEM

PFNA NAIL

Code	Size	Side	Length	Code	Size	Side	Length
5064109170	9 mm	-	180	5064112300	12 mm	R	300
5064109200	9 mm	-	200	5064112320	12 mm	R	320
5064109240	9 mm	-	240	5064112340	12 mm	R	340
5064110170	10 mm	-	180	5064112360	12 mm	R	360
5064110200	10 mm	-	200	5064112380	12 mm	R	380
5064110240	10 mm	-	240	5064112400	12 mm	R	400
5064111170	11 mm	-	180	5064212300	12 mm	L	300
5064111200	11 mm	-	200	5064212320	12 mm	L	320
5064111240	11 mm	-	240	5064212340	12 mm	L	340
5064113170	13 mm	-	180	5064212360	12 mm	L	360
5064113200	13 mm	-	200	5064212380	12 mm	L	380
5064113240	13 mm	-	240	5064212400	12 mm	L	400
5064110300	10 mm	R	300	5064313300	13 mm	R	300
5064110320	10 mm	R	320	5064313320	13 mm	R	320
5064110340	10 mm	R	340	5064313340	13 mm	R	340
5064110360	10 mm	R	360	5064313360	13 mm	R	360
5064110380	10 mm	R	380	5064313380	13 mm	R	380
5064110400	10 mm	R	400	5064313400	13 mm	R	400
5064210300	10 mm	L	300	5064213300	13 mm	L	300
5064210320	10 mm	L	320	5064213320	13 mm	L	320
5064210340	10 mm	L	340	5064213340	13 mm	L	340
5064210360	10 mm	L	360	5064213360	13 mm	L	360
5064210380	10 mm	L	380	5064213380	13 mm	L	380
5064210400	10 mm	L	400	5064213400	13 mm	L	400
5064211300	11 mm	R	300				
5064211320	11 mm	R	320				
5064211340	11 mm	R	340				
5064211360	11 mm	R	360				
5064211380	11 mm	R	380				
5064211400	11 mm	R	400				
5064311300	11 mm	L	300				
5064311320	11 mm	L	320				
5064311340	11 mm	L	340				
5064311360	11 mm	L	360				
5064311380	11 mm	L	380				
5064311400	11 mm	L	400				



Indications

Pertrochanteric fractures, Intertrochanteric fractures, High subtrochanteric fractures, Low subtrochanteric fractures, Femoral shaft fractures, Isolated or combined medial femoral neck fractures.

NAIL SYSTEM

PFNA NAIL

PFNA Compression Locking Screw

Code	Length
5066030065	65
5066030070	70
5066030075	75
5066030080	80
5066030085	85
5066030090	90
5066030095	95
5066030100	100
5066030105	105
5066030110	110
5066030115	115
5066030120	120



PFNA Locking Screw

Code	Size	Length
5006230020	5 mm	20
5006230025	5 mm	25
5006230030	5 mm	30
5006230035	5 mm	35
5006230040	5 mm	40
5006230045	5 mm	45
5006230050	5 mm	50
5006230055	5 mm	55
5006230060	5 mm	60
5006230065	5 mm	65
5006230070	5 mm	70
5006230075	5 mm	75
5006230080	5 mm	80
5006230085	5 mm	85
5006230090	5 mm	90
5006230095	5 mm	95
5006230100	5 mm	100
5006230105	5 mm	105
5006230110	5 mm	110
5006230115	5 mm	115
5006230120	5 mm	120



PFNA Anti-Rotation Locking Screw

Code	Length
7938140065	65
7938140070	70
7938140075	75
7938140080	80
7938140085	85
7938140090	90
7938140095	95
7938140100	100
7938140105	105
7938140110	110
7938140115	115
7938140120	120



PFNA Nail End Cap

Code	Size
5007030000	0
5007030005	5 mm
5007030010	10 mm
5007030015	15 mm
5007030020	20 mm



PFNA Nail End Cap Insert Locking Screw

Code	Size
5007030025	-



NAIL SYSTEM

INTRAMEDULLARY CANNULATED LATERAL FEMUR NAIL

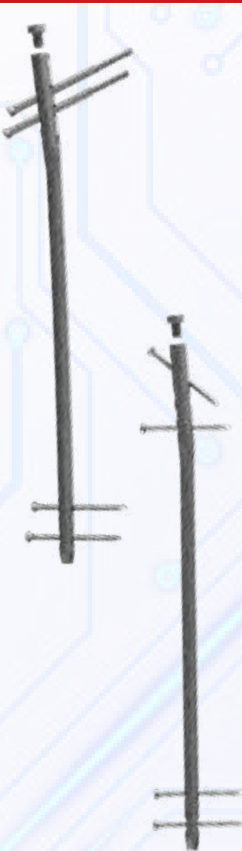
Code	Size	Side	Length		Code	Size	Side	Length
5064318300	9,5 mm	R	300		5064111300	11,5 mm	R	300
5064318320	9,5 mm	R	320		5064111320	11,5 mm	R	320
5064318340	9,5 mm	R	340		5064111340	11,5 mm	R	340
5064318360	9,5 mm	R	360		5064111360	11,5 mm	R	360
5064318380	9,5 mm	R	380		5064111380	11,5 mm	R	380
5064318400	9,5 mm	R	400		5064111400	11,5 mm	R	400
5064318420	9,5 mm	R	420		5064111420	11,5 mm	R	420
5064318440	9,5 mm	R	440		5064111440	11,5 mm	R	440
5064328400	9,5 mm	L	300		5064221300	11,5 mm	L	300
5064328420	9,5 mm	L	320		5064221320	11,5 mm	L	320
5064328440	9,5 mm	L	340		5064221340	11,5 mm	L	340
5064328460	9,5 mm	L	360		5064221360	11,5 mm	L	360
5064328480	9,5 mm	L	380		5064221380	11,5 mm	L	380
5064328500	9,5 mm	L	400		5064221400	11,5 mm	L	400
5064328520	9,5 mm	L	420		5064221420	11,5 mm	L	420
5064328540	9,5 mm	L	440		5064221440	11,5 mm	L	440
5064118300	10 mm	R	300		5064113300	12 mm	R	300
5064118320	10 mm	R	320		5064113320	12 mm	R	320
5064118340	10 mm	R	340		5064113340	12 mm	R	340
5064118360	10 mm	R	360		5064113360	12 mm	R	360
5064118380	10 mm	R	380	5064113380	12 mm	R	380	
5064118400	10 mm	R	400	5064113400	12 mm	R	400	
5064110420	10 mm	R	420	5064113420	12 mm	R	420	
5064110440	10 mm	R	440	5064113440	12 mm	R	440	
5064220300	10 mm	L	300	5064223300	12 mm	L	300	
5064220320	10 mm	L	320	5064223320	12 mm	L	320	
5064220340	10 mm	L	340	5064223340	12 mm	L	340	
5064220360	10 mm	L	360	5064223360	12 mm	L	360	
5064220380	10 mm	L	380	5064223380	12 mm	L	380	
5064220400	10 mm	L	400	5064223400	12 mm	L	400	
5064220420	10 mm	L	420	5064223420	12 mm	L	420	
5064220440	10 mm	L	440	5064223440	12 mm	L	440	

Indications

Lateral Femoral Nail with standard locking is indicated for fractures in the femoral shaft except subtrochanteric fractures femoral shaft in case of combination with femoral neck fractures: combined with double ipsilateral fractures indicated for fractures in the subtrochanteric section.

NAIL SYSTEM

INTRAMEDULLARY CANNULATED LATERAL FEMUR NAIL

Lateral Femur Nail Cannulated Lag Screw

Code	Side	Length
5066230065	6,5	65
5066230070	6,5	70
5066230075	6,5	75
5066230080	6,5	80
5066230085	6,5	85
5066230090	6,5	90
5066230095	6,5	95
5066230100	6,5	100
5066230105	6,5	105
5066230110	6,5	110
5066230115	6,5	115
5066230120	6,5	120



Lateral Femur Nail Locking Screw

Code	Size	Length
5064205020	5 mm	20
5064205025	5 mm	25
5064205028	5 mm	28
5064205030	5 mm	30
5064205032	5 mm	32
5064205034	5 mm	34
5064205035	5 mm	35
5064205036	5 mm	36
5064205038	5 mm	38
5064205040	5 mm	40
5064205042	5 mm	42
5064205044	5 mm	44
5064205045	5 mm	45
5064205048	5 mm	48
5064205050	5 mm	50
5064205052	5 mm	52
5064205054	5 mm	54
5064205055	5 mm	55
5064205056	5 mm	56
5064205058	5 mm	58
5064205060	5 mm	60
5064205064	5 mm	64
5064205065	5 mm	65
5064205068	5 mm	68
5064205070	5 mm	70
5064205072	5 mm	72
5064205074	5 mm	74
5064205075	5 mm	75
5064205076	5 mm	76
5064205078	5 mm	78
5064205080	5 mm	80
5064205085	5 mm	85
5064205090	5 mm	90
5064205095	5 mm	95
5064205100	5 mm	100
5064205105	5 mm	105
5064205110	5 mm	110
5064205115	5 mm	115
5064205120	5 mm	120



Lateral Femur Nail End Cap

Code	Side
5007031000	0
5007031005	5 mm
5007031010	10 mm
5007031015	15 mm
5007031020	20 mm



NAIL SYSTEM

TIBIAL NAIL CANNULATED

Code	Size	Length
5074208255	8,4 mm	255
5074208270	8,4 mm	270
5074208280	8,4 mm	285
5074208300	8,4 mm	300
5074208315	8,4 mm	315
5074208330	8,4 mm	330
5074208345	8,4 mm	345
5074208360	8,4 mm	360
5074208375	8,4 mm	375
5074208400	8,4 mm	400

5074209255	9 mm	255
5074209270	9 mm	270
5074209280	9 mm	285
5074209300	9 mm	300
5074209320	9 mm	315
5074209330	9 mm	330
5074209340	9 mm	345
5074209360	9 mm	360
5074209380	9 mm	375
5074209400	9 mm	400

5074210255	10 mm	255
5074210270	10 mm	270
5074210280	10 mm	285
5074210300	10 mm	300
5074210320	10 mm	315
5074210330	10 mm	330
5074210340	10 mm	345
5074210360	10 mm	360
5074210380	10 mm	375
5074210400	10 mm	400

Code	Size	Length
5074211255	11 mm	255
5074211270	11 mm	270
5074211280	11 mm	285
5074211300	11 mm	300
5074211320	11 mm	315
5074211330	11 mm	330
5074211340	11 mm	345
5074211360	11 mm	360
5074211380	11 mm	375
5074211400	11 mm	400

5074212270	12 mm	270
5074212280	12 mm	285
5074212300	12 mm	300
5074212320	12 mm	315
5074212330	12 mm	330
5074212340	12 mm	345
5074212360	12 mm	360
5074212380	12 mm	375
5074212400	12 mm	400



Indications

Fractures in the tibial shaft as well as for metaphyseal and certain intraarticular fractures of the tibial head and the pilon tibial.

NAIL SYSTEM

TIBIAL NAIL CANNULATED

Tibial Nail Locking Screw

Code	Size	Length
5076235025	4,8 mm	25
5076235030	4,8 mm	30
5076235035	4,8 mm	35
5076235040	4,8 mm	40
5076235045	4,8 mm	45
5076235050	4,8 mm	50
5076235055	4,8 mm	55
5076235060	4,8 mm	60
5076235065	4,8 mm	65
5076235070	4,8 mm	70
5076235075	4,8 mm	75
5076235080	4,8 mm	80
5076235085	4,8 mm	85
5076235090	4,8 mm	90
5076235095	4,8 mm	95
5076235010	4,8 mm	100



Tibial Nail Locking Screw

Code	Size	Length
5076234520	4,5 mm	20
5076234524	4,5 mm	24
5076234525	4,5 mm	25
5076234526	4,5 mm	26
5076234528	4,5 mm	28
5076234530	4,5 mm	30
5076234532	4,5 mm	32
5076234534	4,5 mm	34
5076234535	4,5 mm	35
5076234536	4,5 mm	36
5076234538	4,5 mm	38
5076234540	4,5 mm	40
5076234542	4,5 mm	42
5076234544	4,5 mm	44
5076234545	4,5 mm	45
5076234546	4,5 mm	46
5076234548	4,5 mm	48
5076234550	4,5 mm	50
5076234554	4,5 mm	54
5076234555	4,5 mm	55
5076234560	4,5 mm	60
5076234565	4,5 mm	65
5076234570	4,5 mm	70
5076234575	4,5 mm	75
5076234580	4,5 mm	80
5076234585	4,5 mm	85
5076234590	4,5 mm	90
5076234595	4,5 mm	95
5076234510	4,5 mm	100



Tibial Nail End

Code	Cap Size
5007032000	0
5007032005	5 mm
5007032010	10 mm
5007032015	15 mm
5007032020	20 mm



NAIL SYSTEM

ARTHRODESIS NAIL

Code	Size	Length
8501000150	10 mm	150
8501000175	10 mm	175
8501000200	10 mm	200
8501000225	10 mm	225
8501100150	11 mm	150
8501100175	11 mm	175
8501100200	11 mm <td 200	
8501100225	11 mm	225

Arthrodesis Locking Screw

Code	Size	Length
6026230020	5.0 mm	20
6026230025	5.0 mm	25
6026230030	5.0 mm	30
6026230035	5.0 mm	35
6026230040	5.0 mm	40
6026230045	5.0 mm	45
6026230050	5.0 mm	50
6026230055	5.0 mm	55
6026230060	5.0 mm	60
6026230065	5.0 mm	65
6026230070	5.0 mm	70
6026230075	5.0 mm	75
6026230080	5.0 mm	80

Arthrodesis Nail End Cap

Code	Size
6026230085	0

Indications

Pertrochanteric fractures, Intertrochanteric fractures, High subtrochanteric fractures, Low subtrochanteric fractures, Femoral shaft fractures, Isolated or combined medial femoral neck fractures.



FLEXIBLE INTRAMEDULLARY NAIL

Code	Size	Length
5032202040	2,0 mm	400
5032202540	2,5 mm	400
5032203040	3,0 mm	400
5032203540	3,5 mm	400
5032204040	4,0 mm	400
5032204540	4,5 mm	400
5032205040	5,0 mm	400

Flexible Nail End Cap

Code	Size
5032202041	0
5037030000	0



Indications

The management of diaphyseal and certain metaphyseal/-epiphyseal fractures of long bones in children and young adults.

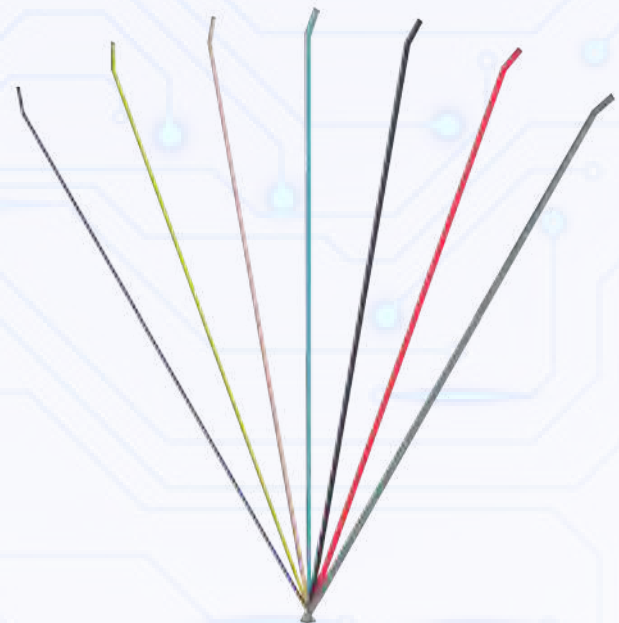

MEDICAL
4U[®]

Turkey



International Organization for Standardization
ISO
13485



www.4umedical.com.tr

Keeps You Moving

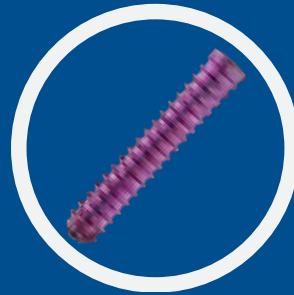
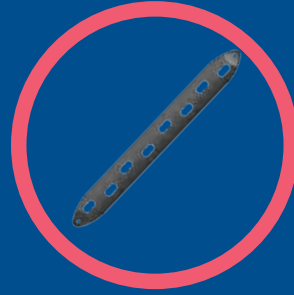

**4U Mak. Medical
Oto.San.Tic.Ltd.Sti.**

-  Turgut Ozal Mah. 2118.Cd.No:6/A
Yenimahalle/Ankara-TURKIYE
-  +90 312 566 06 55
-  +90 532 677 42 32
-  info@4umedical.com.tr



www.4umedical.com.tr

